

Casing Patterns

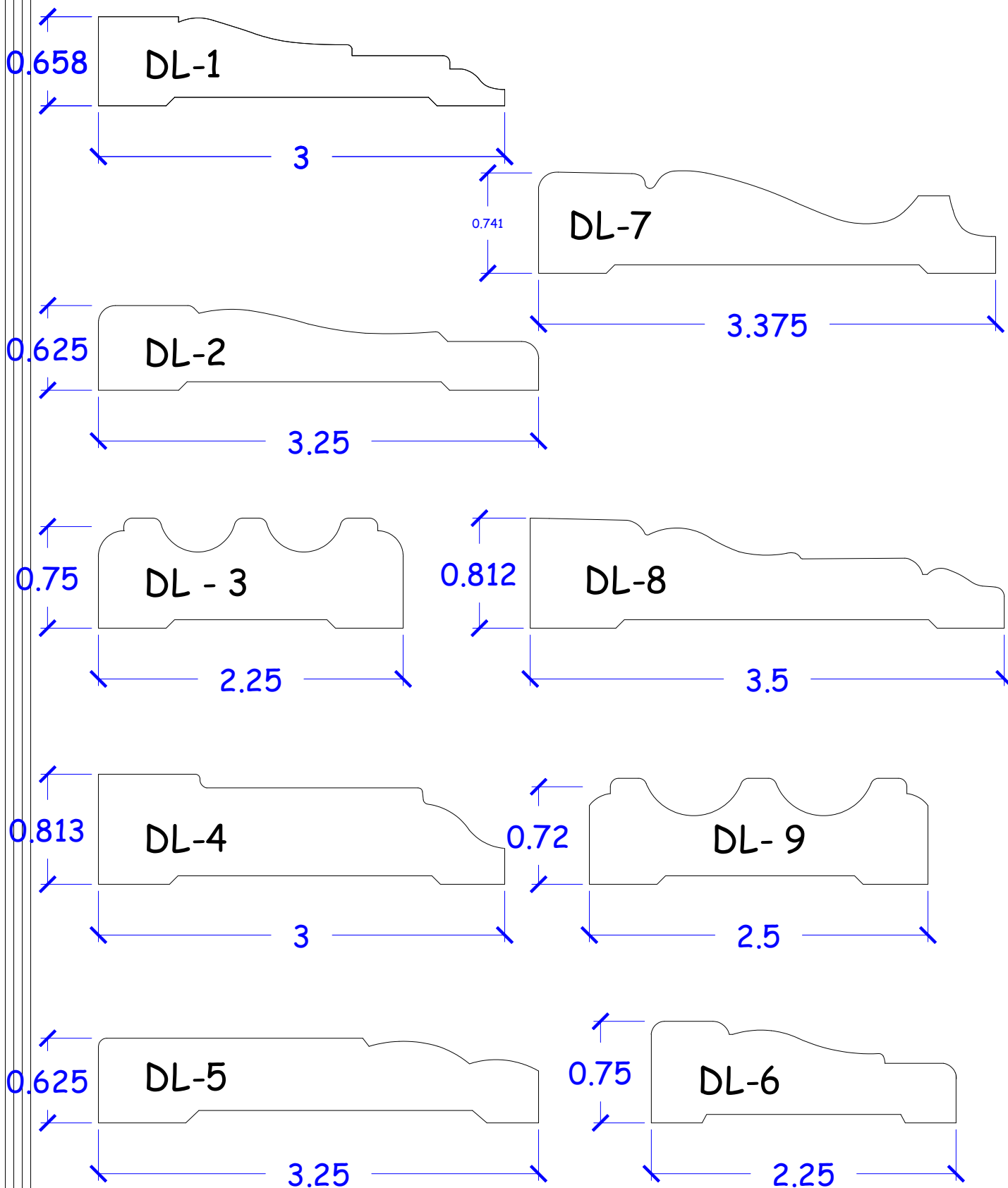

Casing Patterns

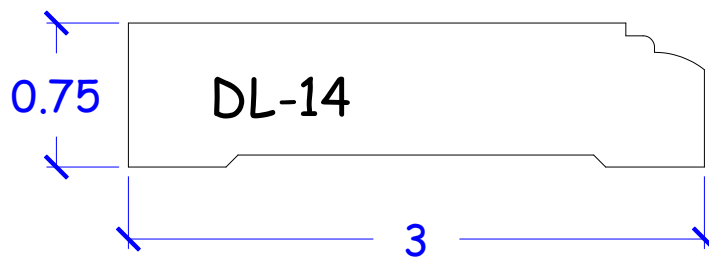
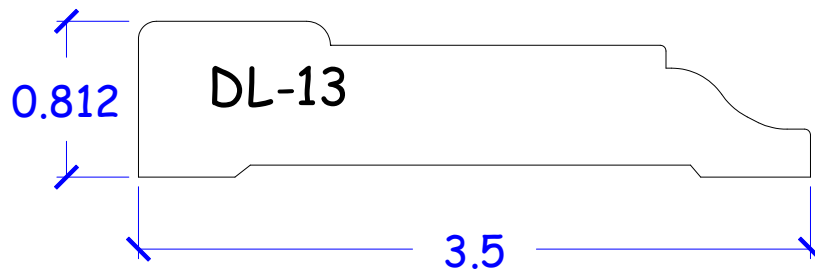
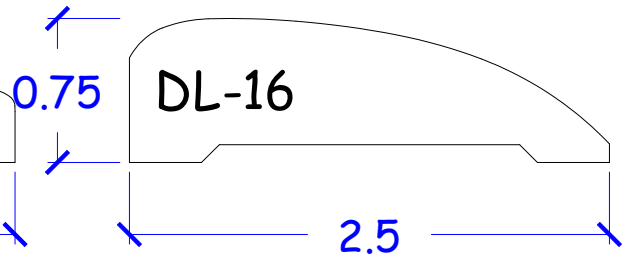
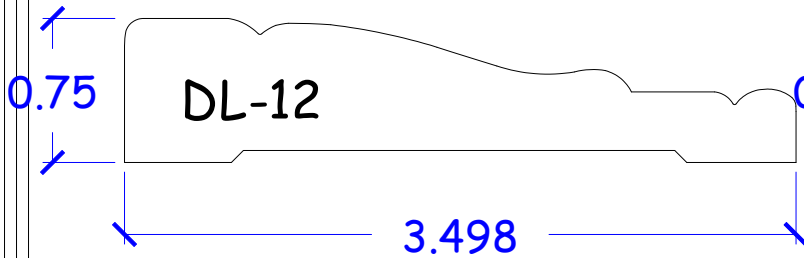
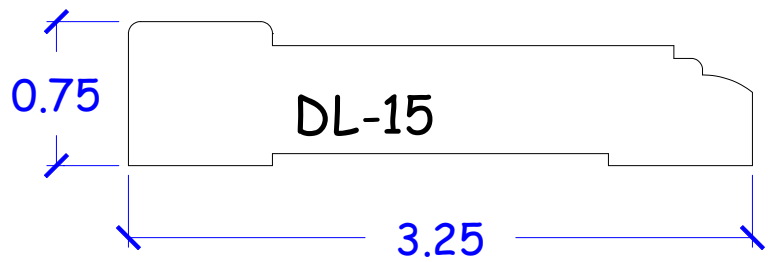
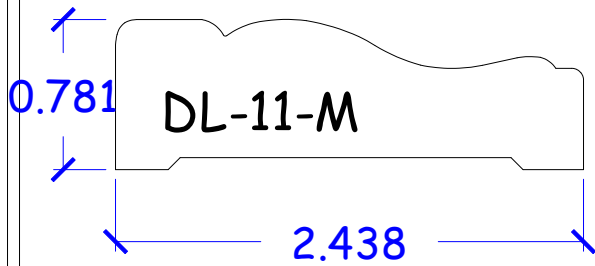
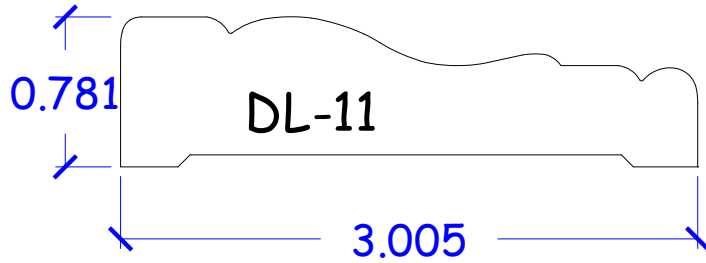
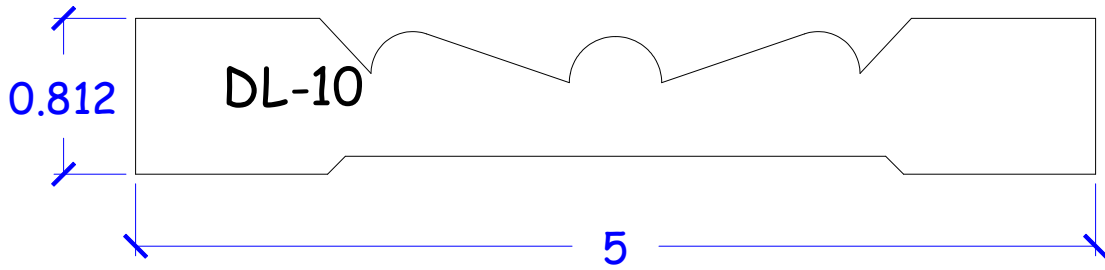

Casing Patterns

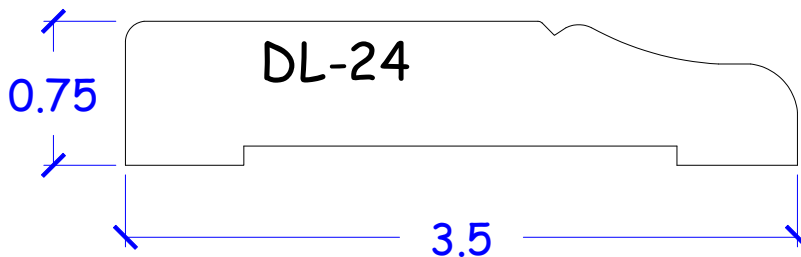
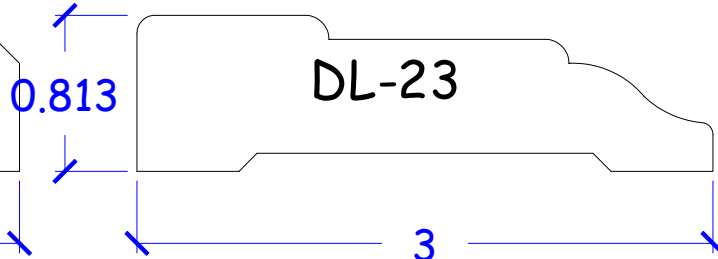
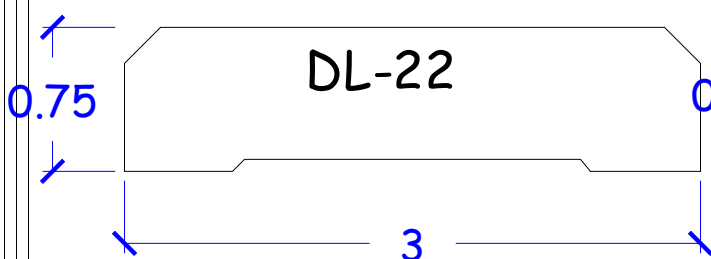
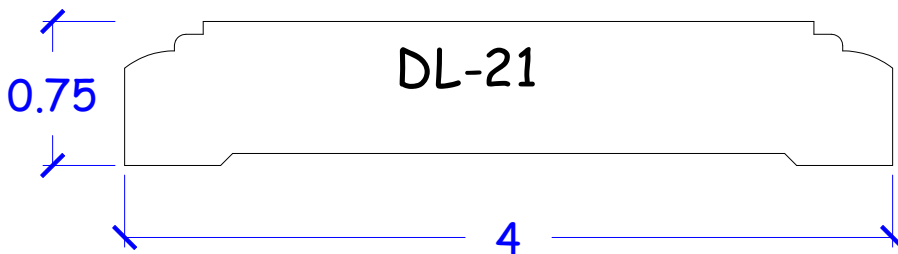
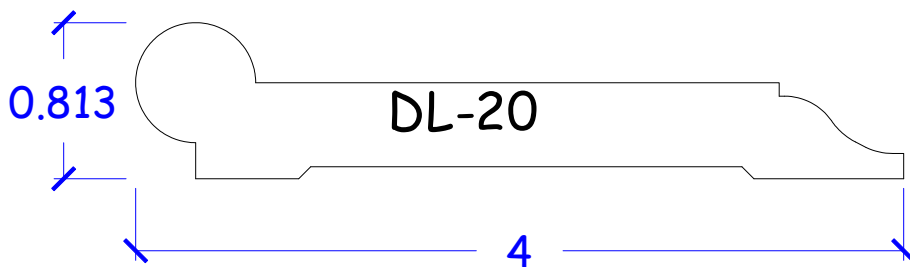
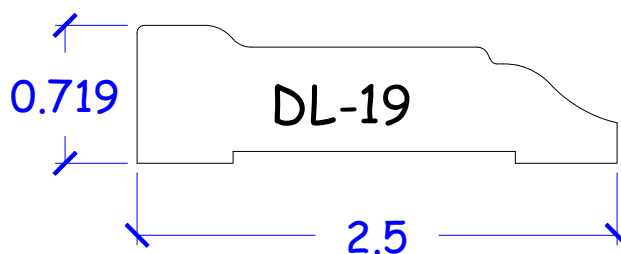
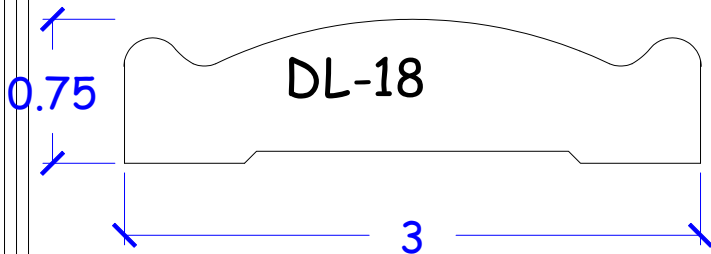
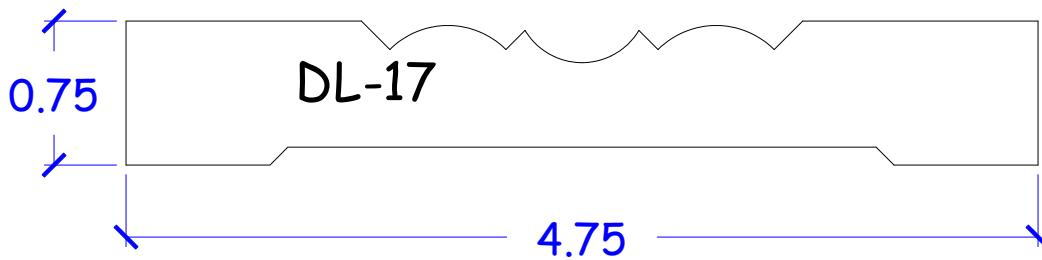

Casing Patterns

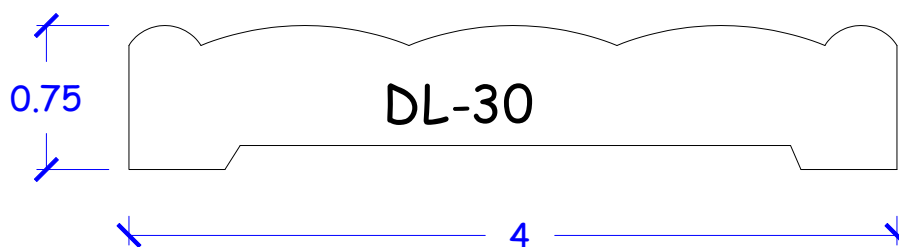
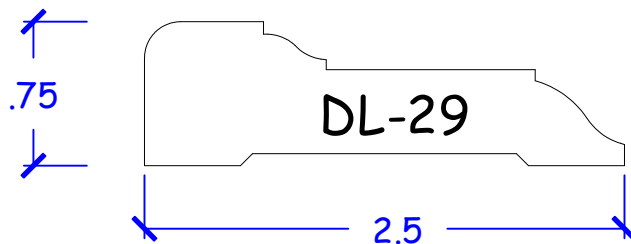
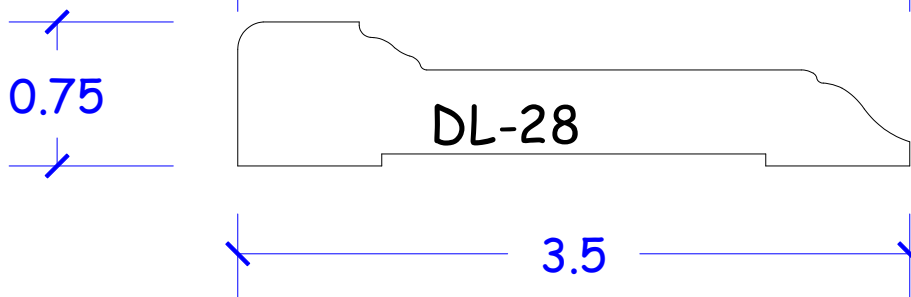
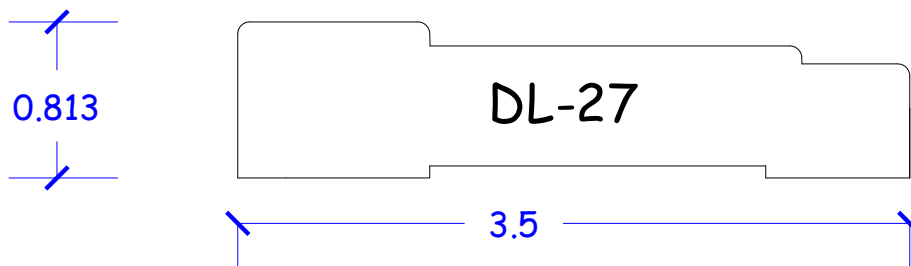
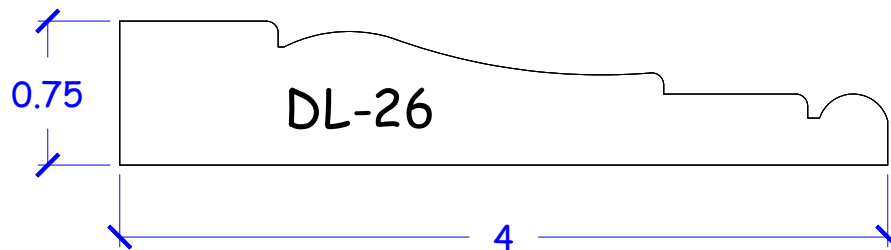
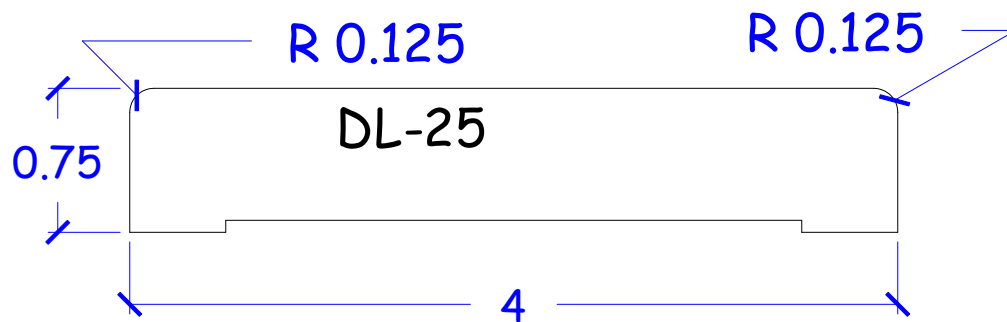

Casing Patterns

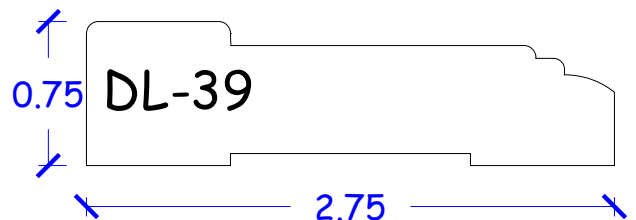
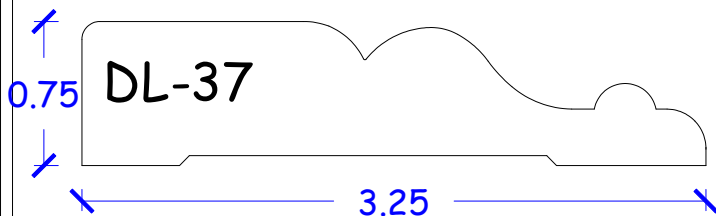
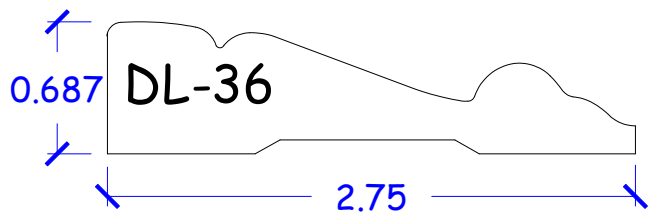
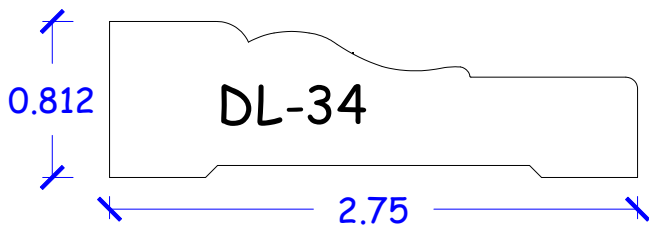
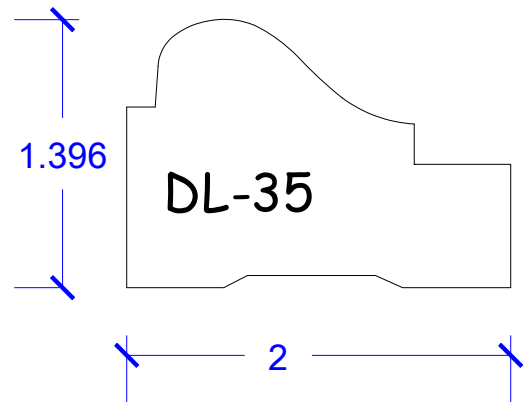
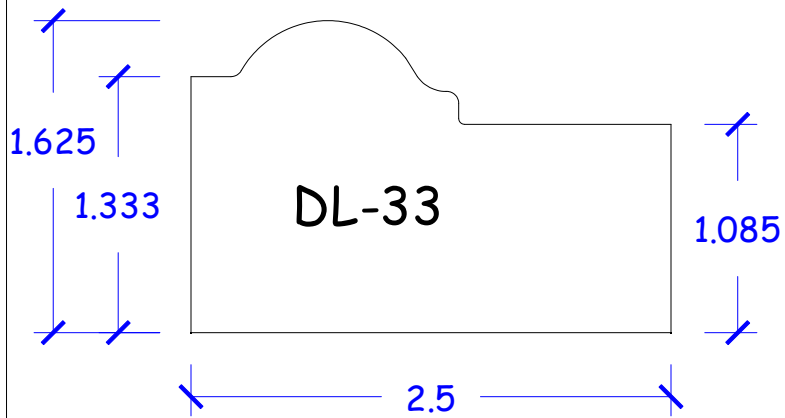
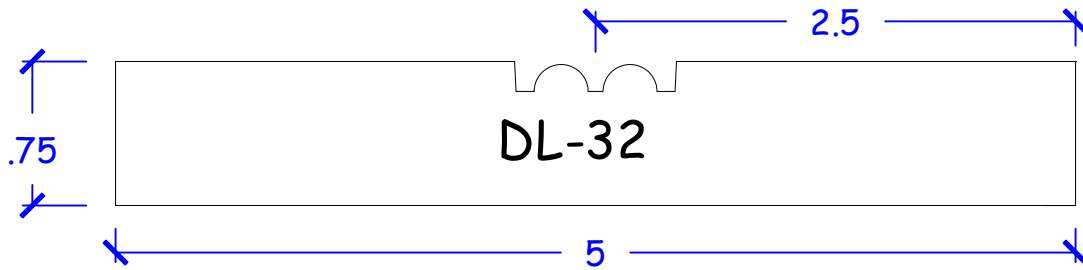
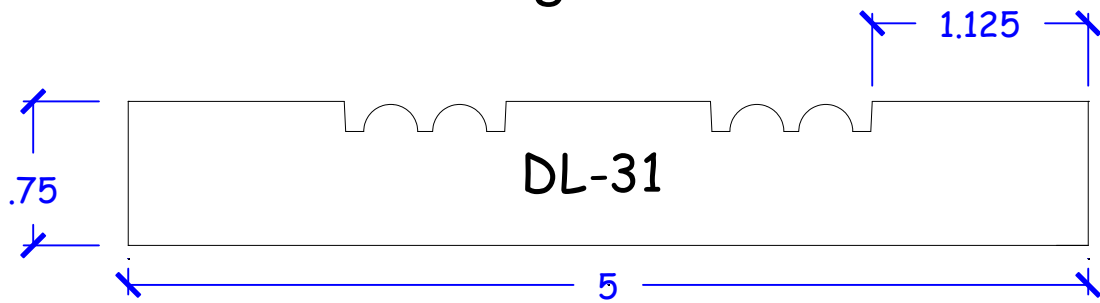

Casing Patterns

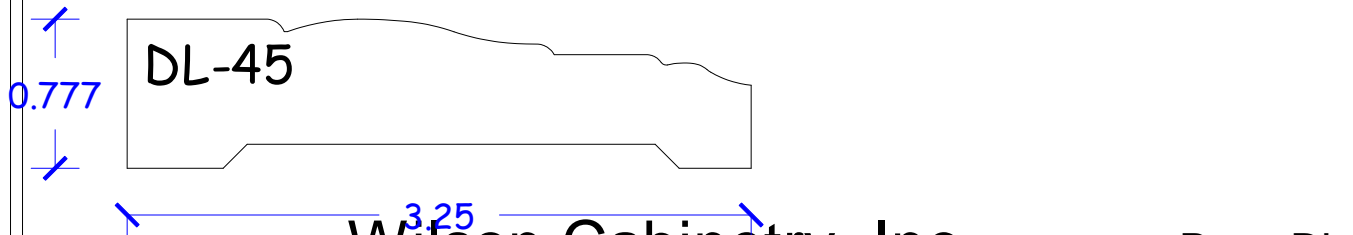
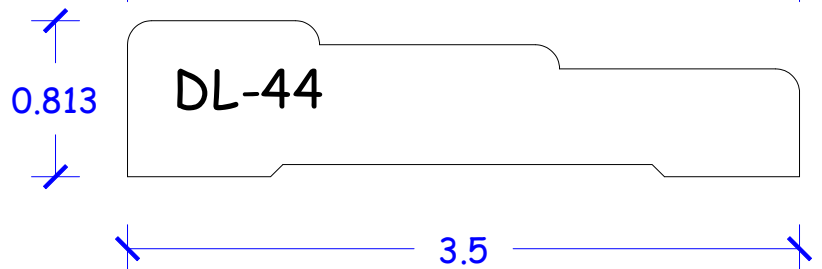
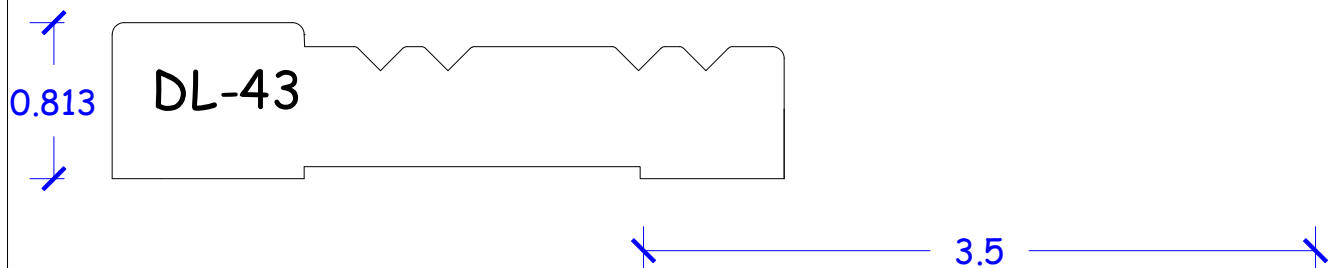
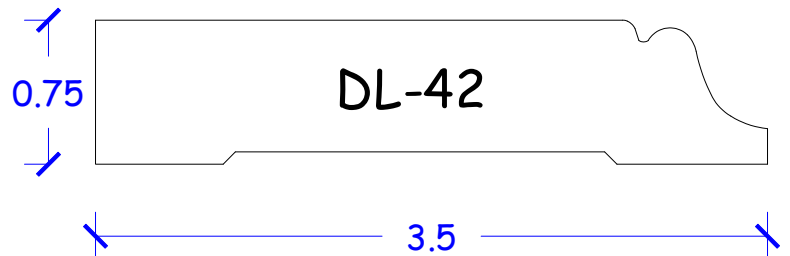
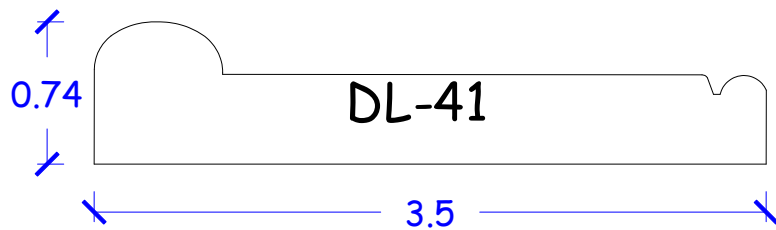
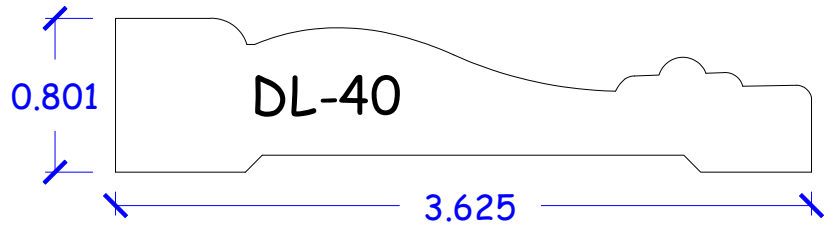
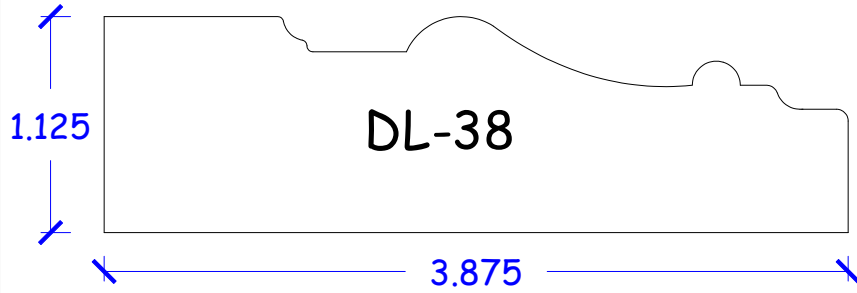

Casing Patterns

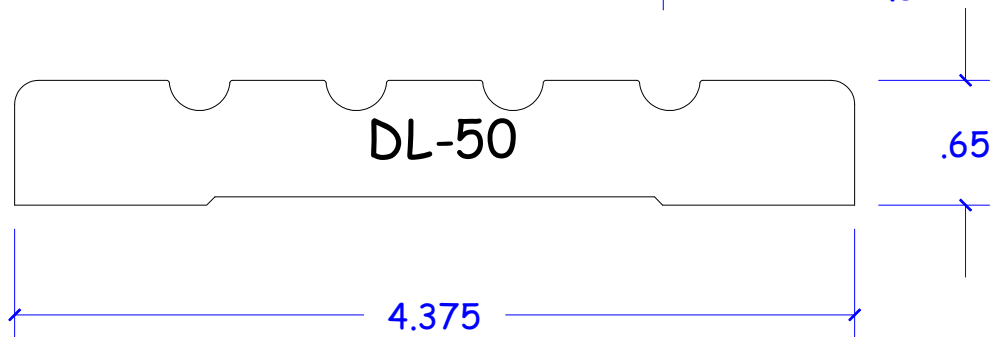
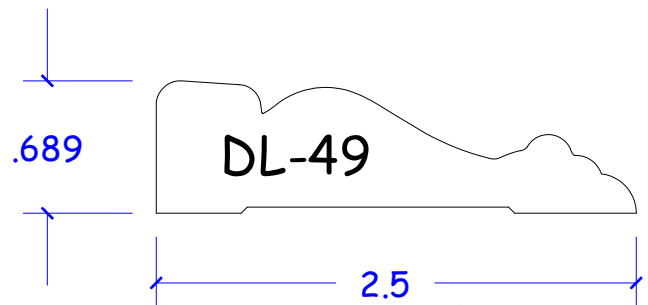
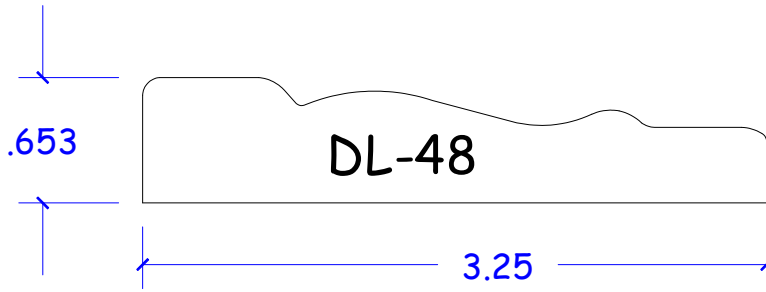
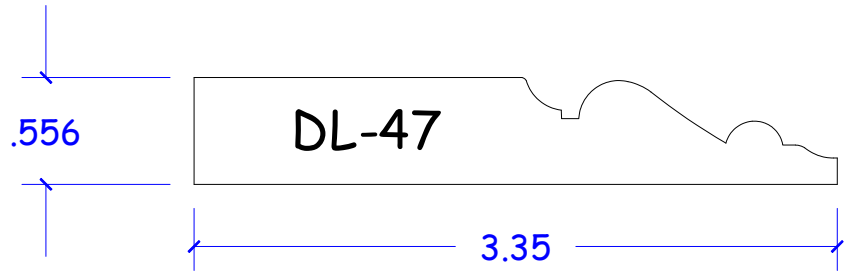
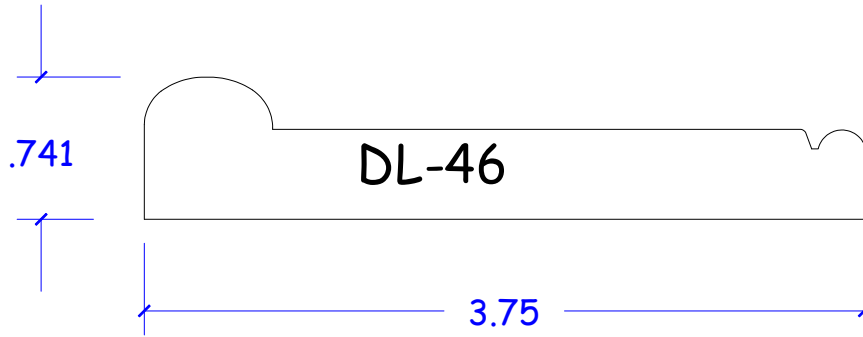

Casing Patterns

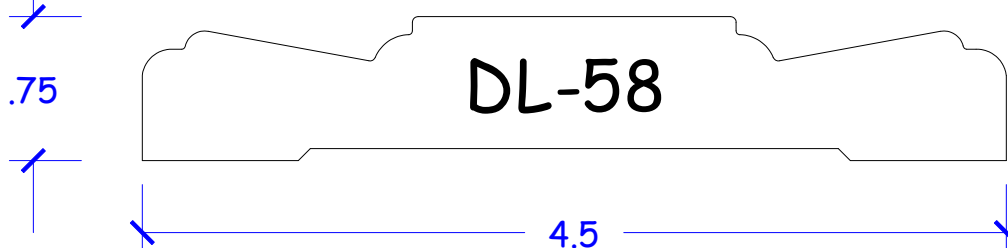
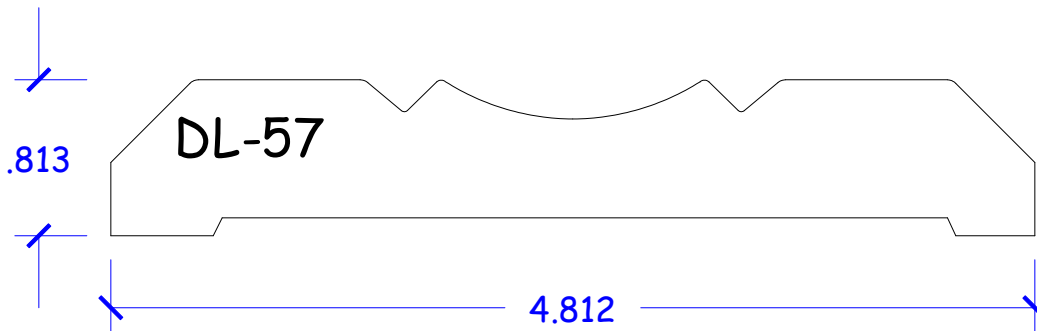
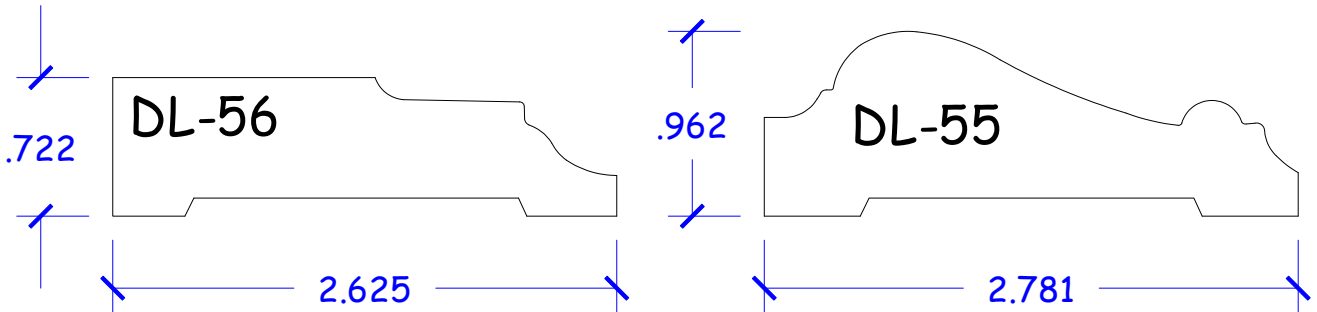
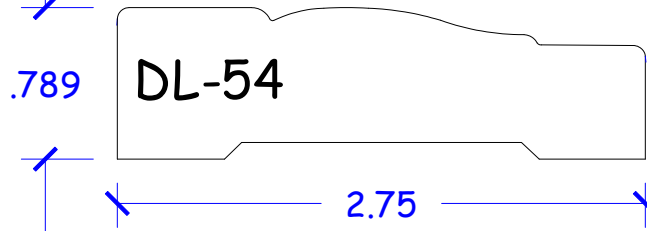
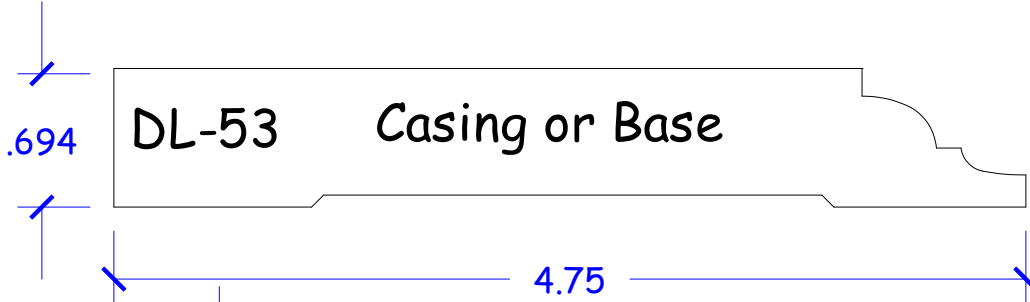
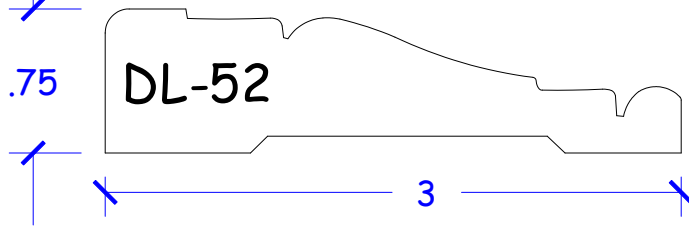

Casing Patterns

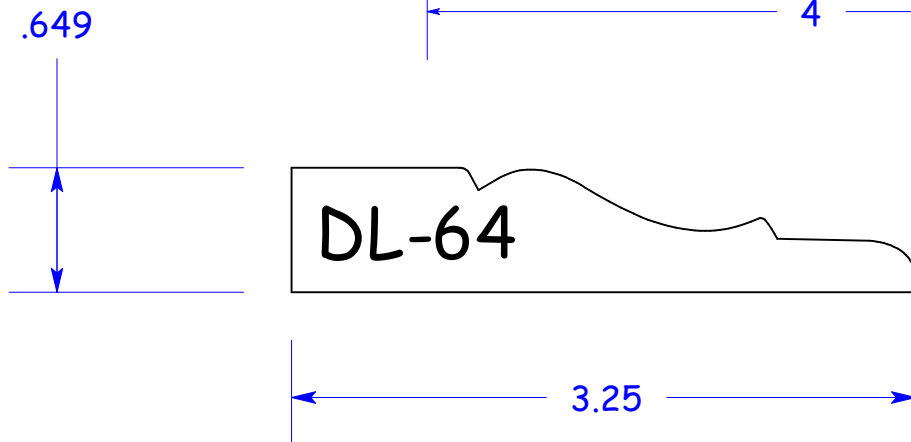
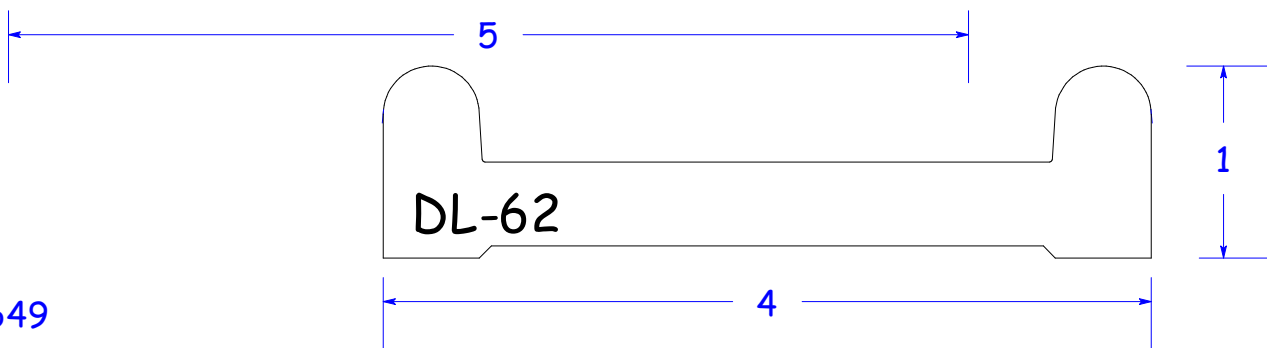
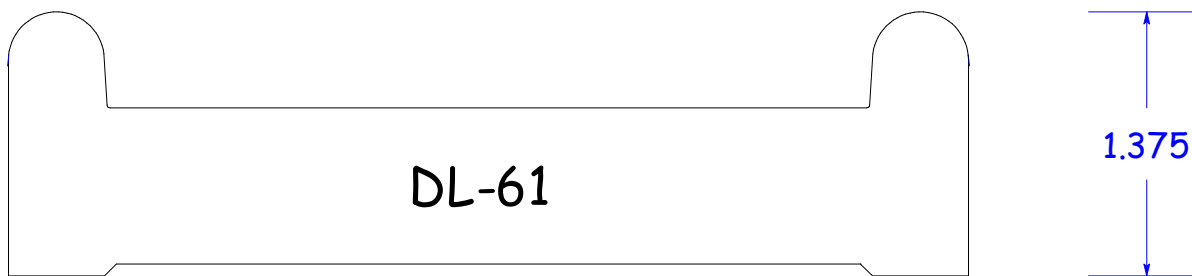
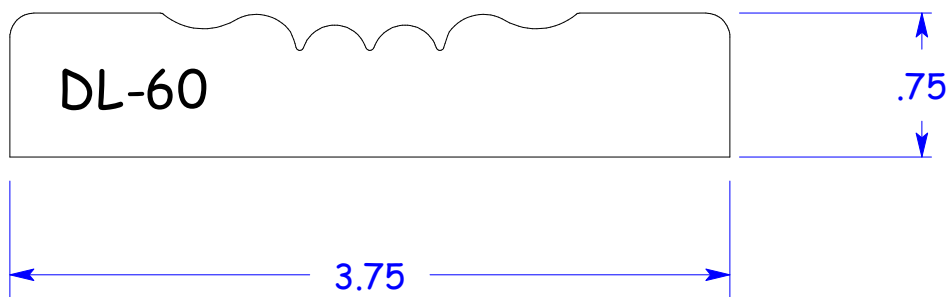
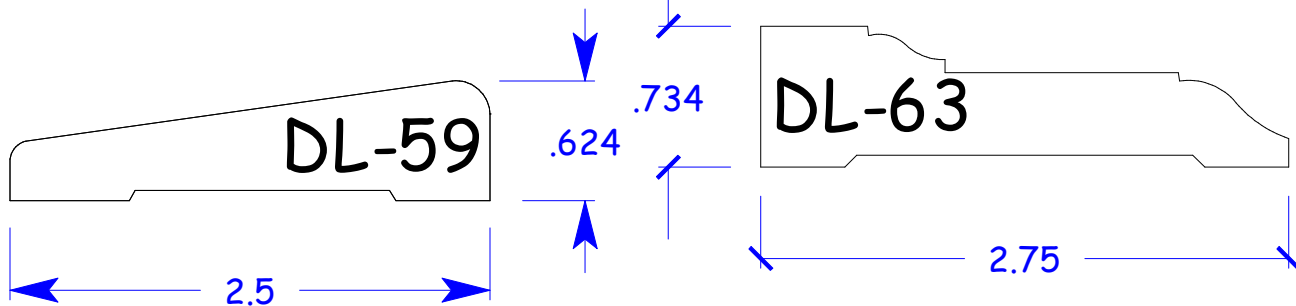

Casing Patterns

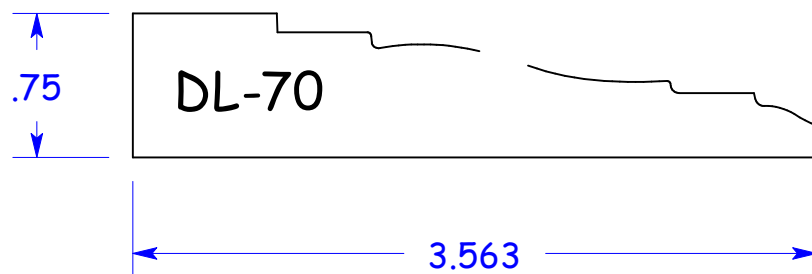
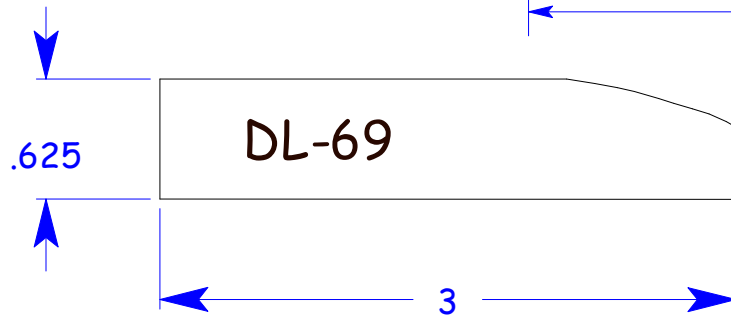
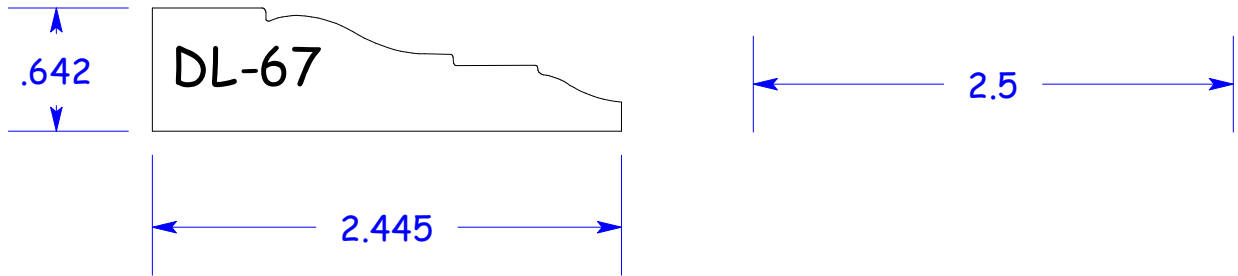
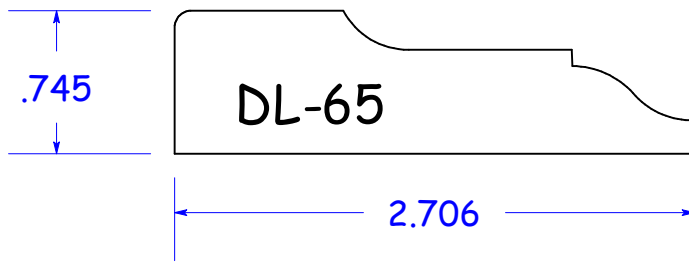

Casing Patterns

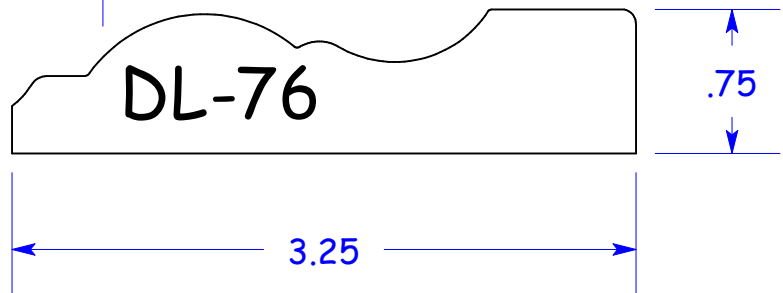
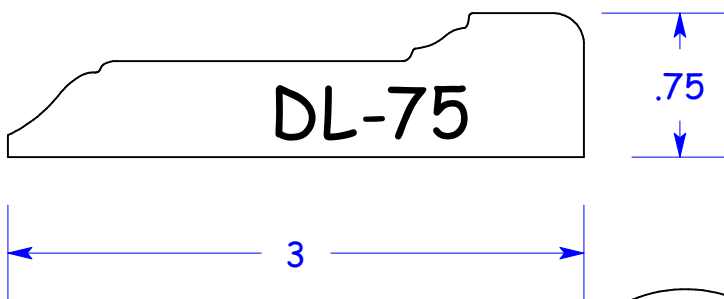
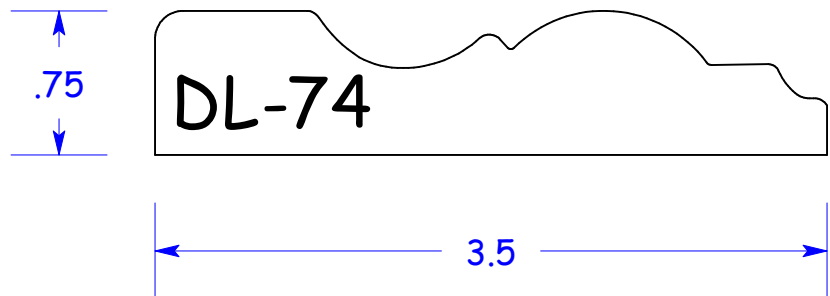
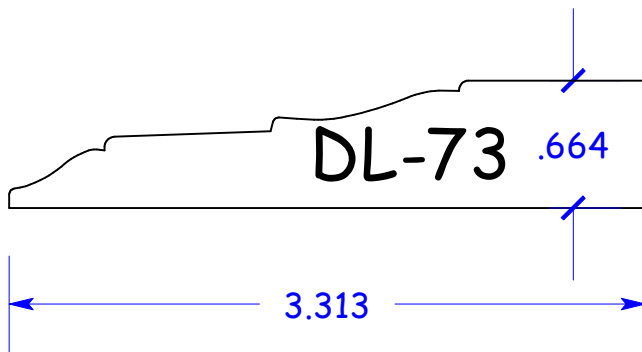
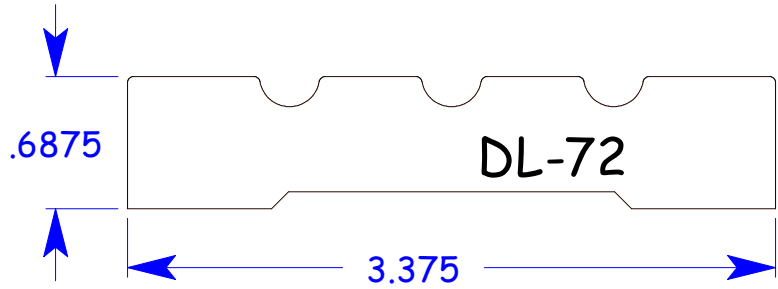
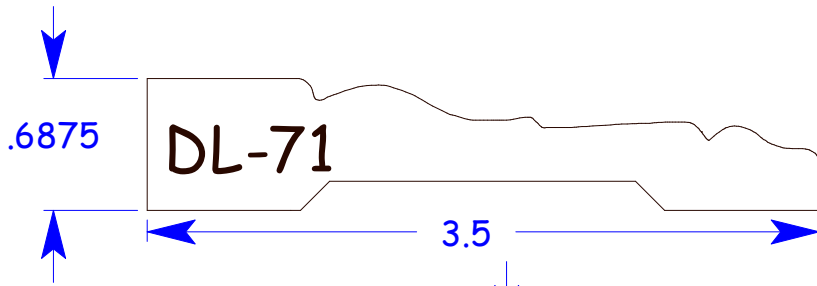

Casing Patterns

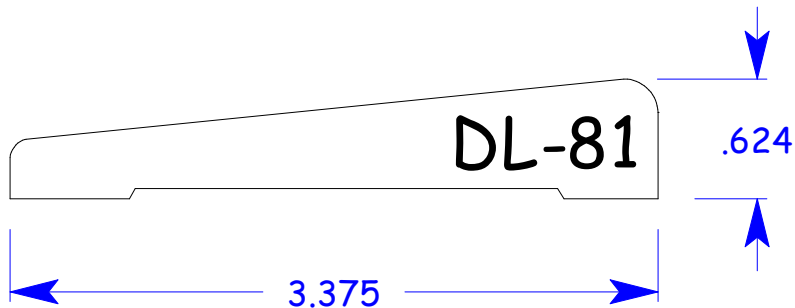
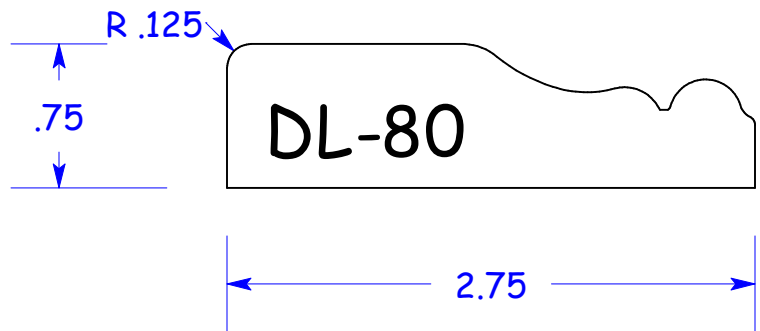
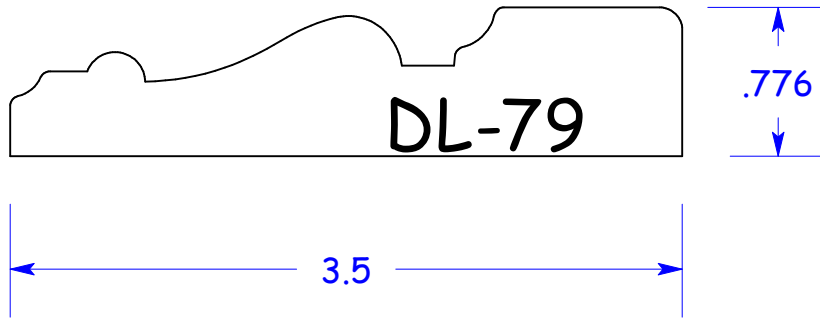
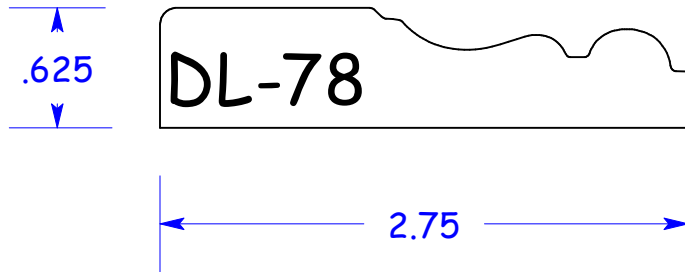
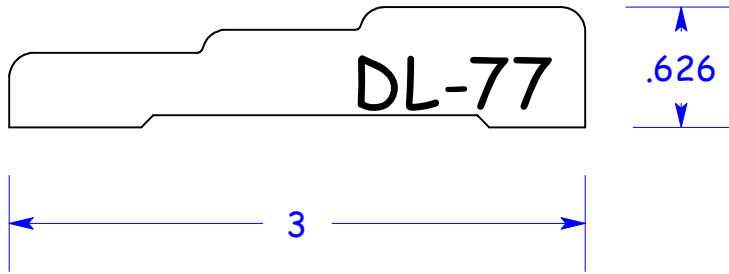

Casing Patterns

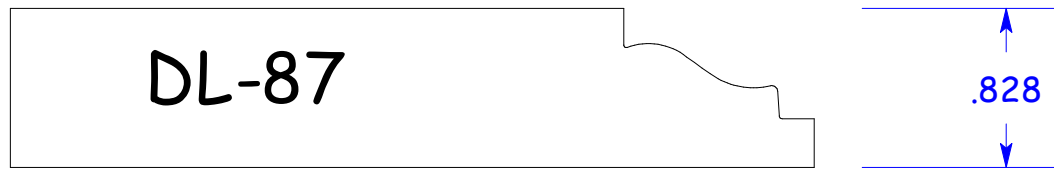
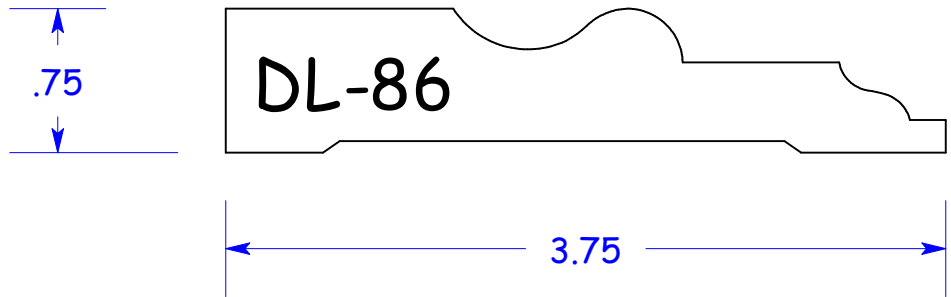
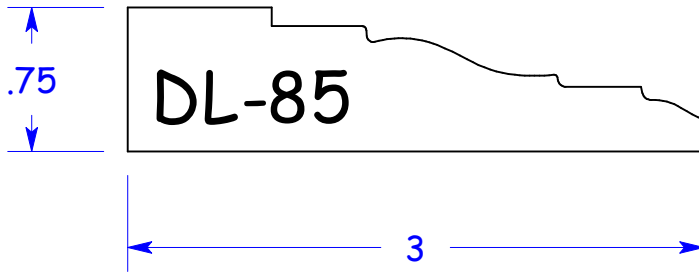
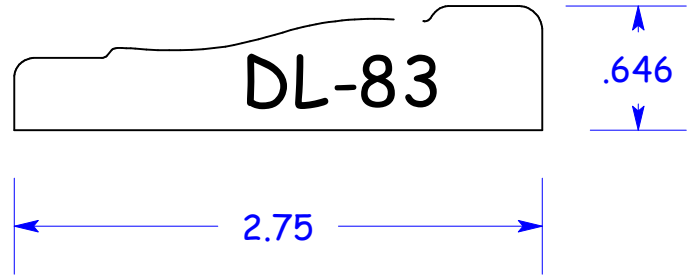
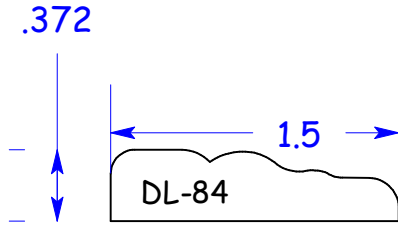
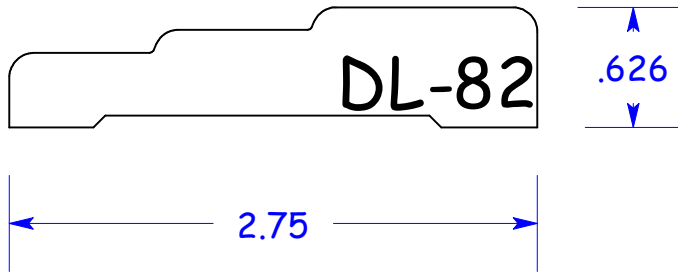

Casing Patterns

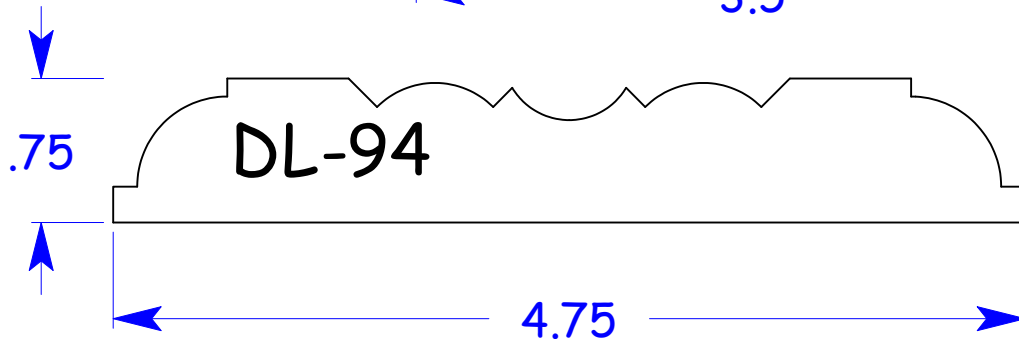
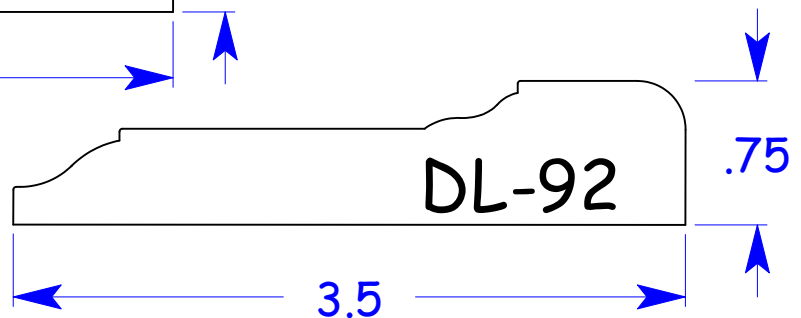
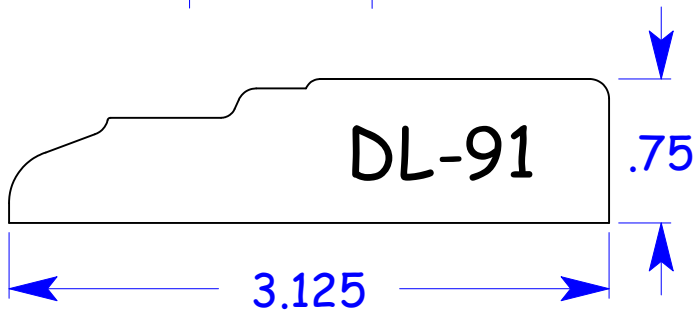
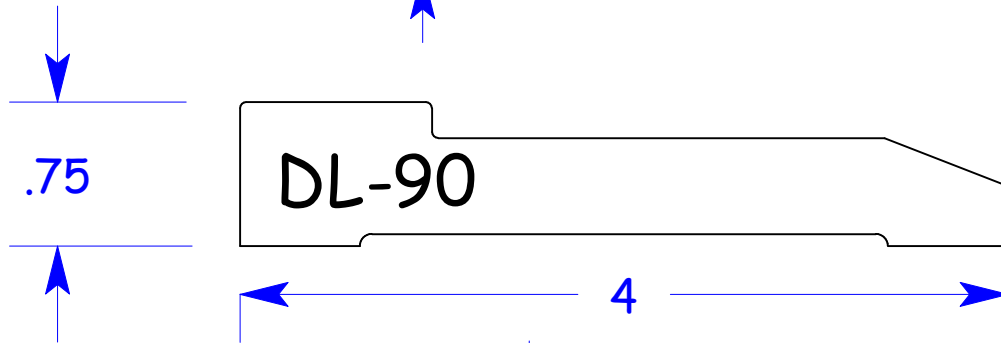
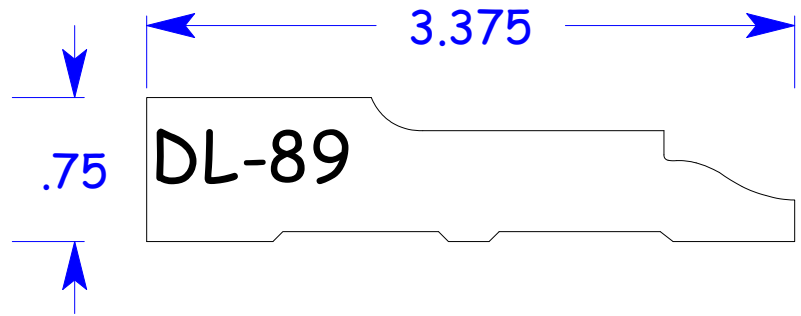
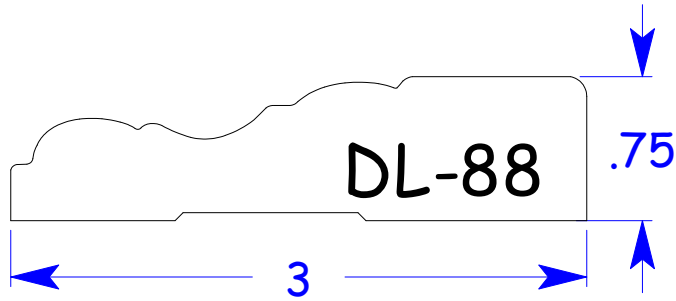

Casing Patterns

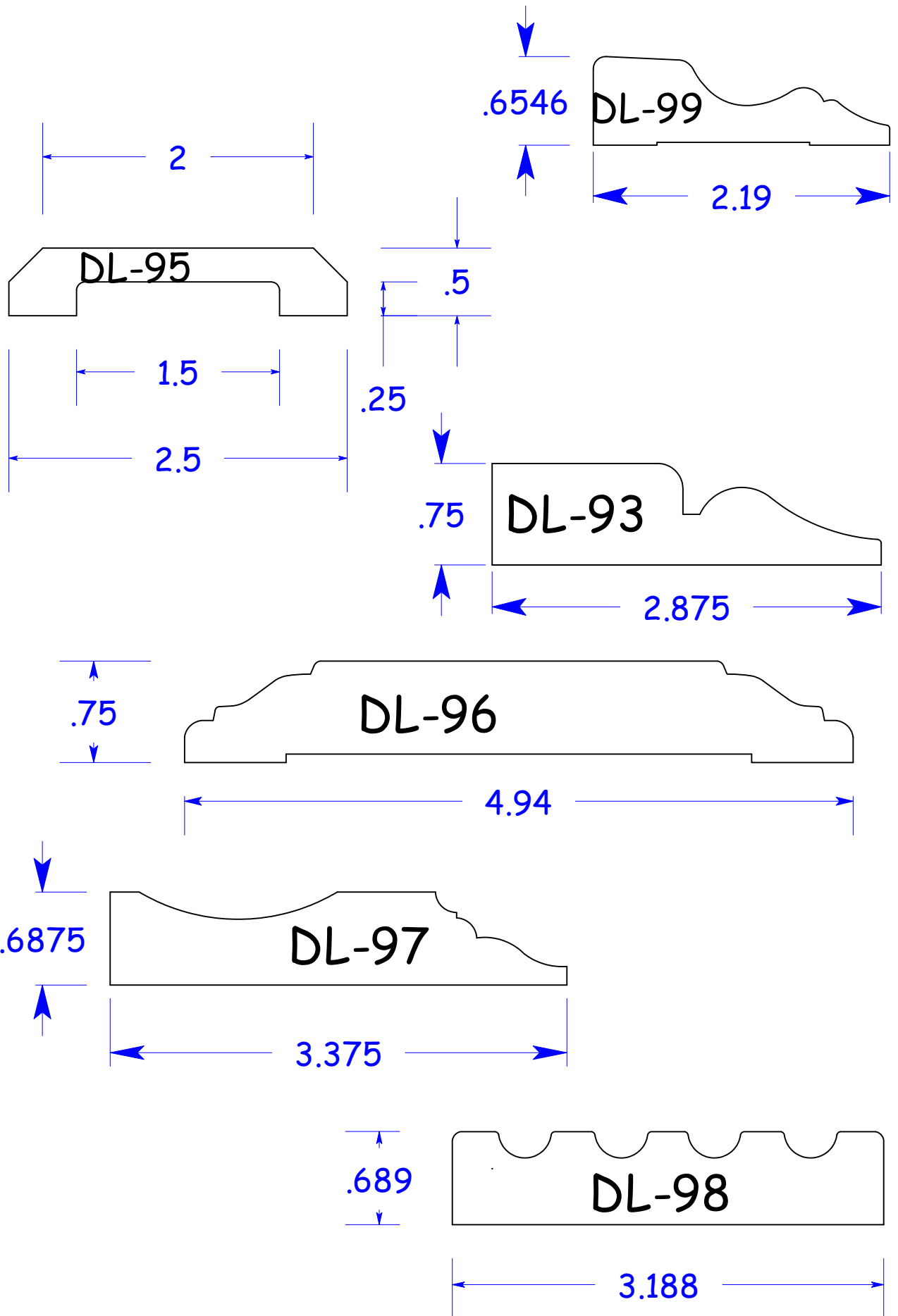

Casing Patterns

