

MISC. Patterns

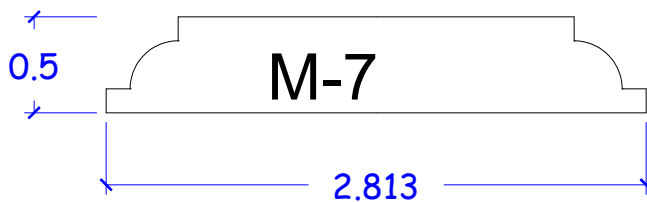

MISC. Patterns

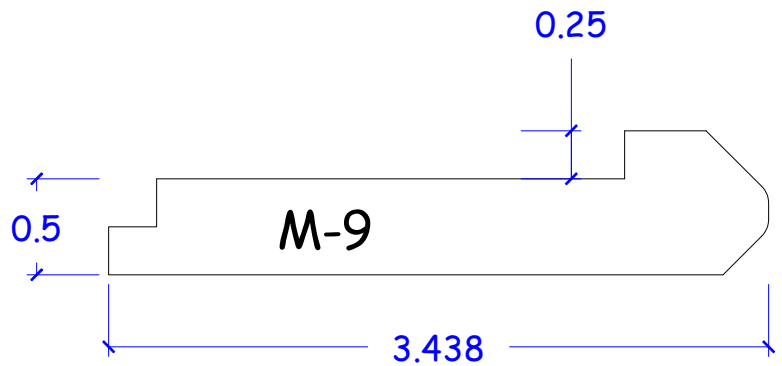
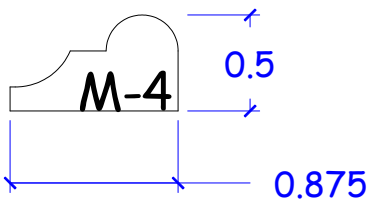
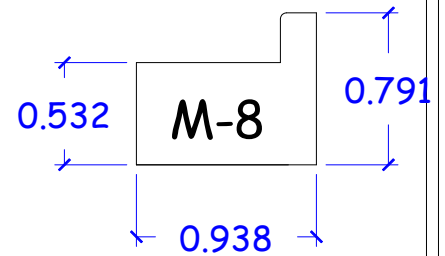
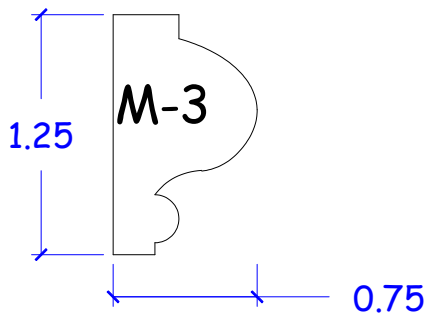
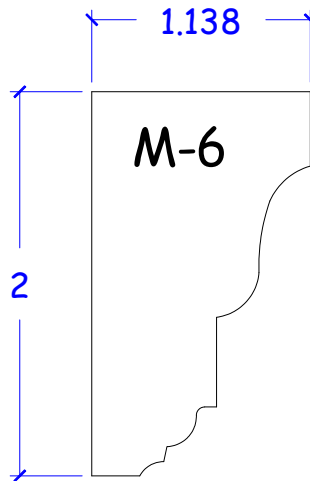
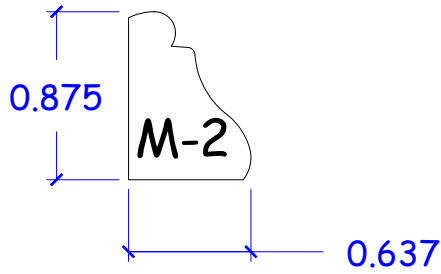
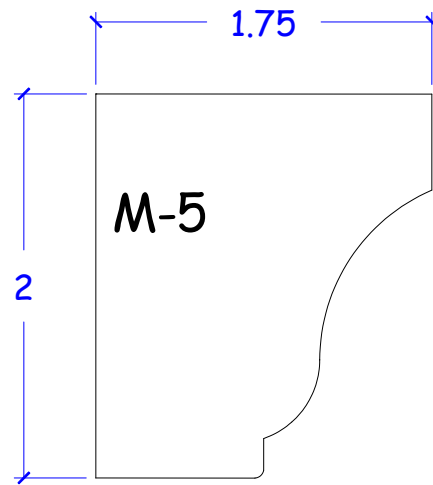
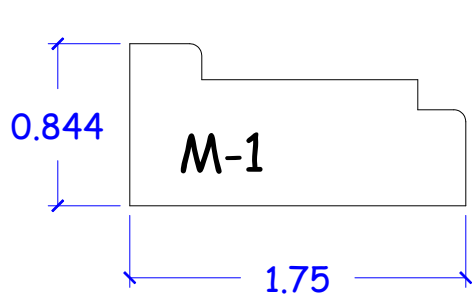
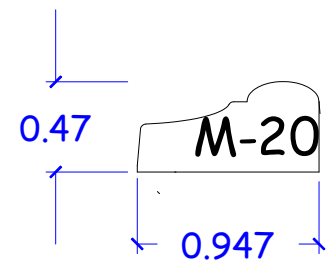
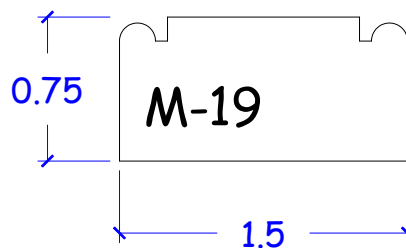
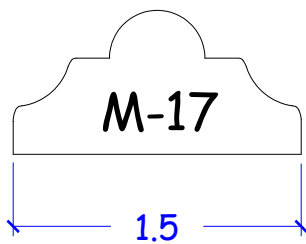
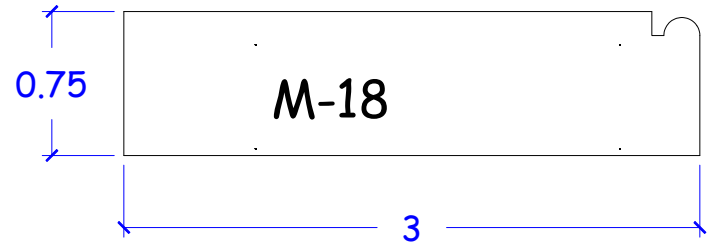
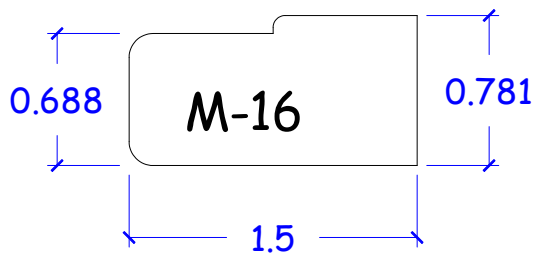
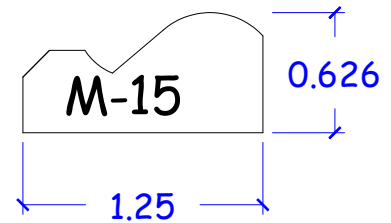
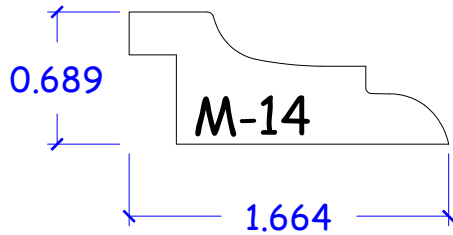
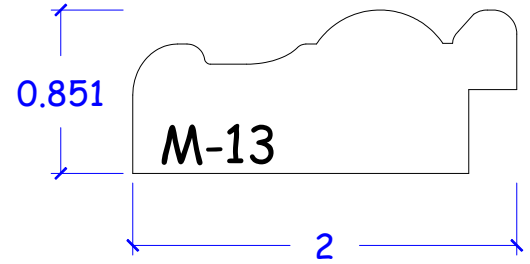
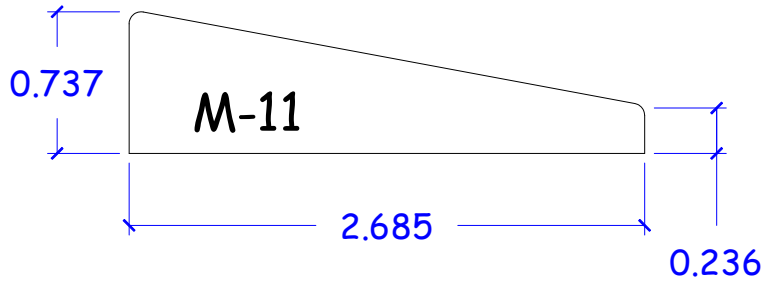
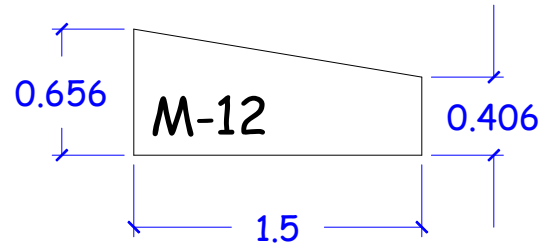
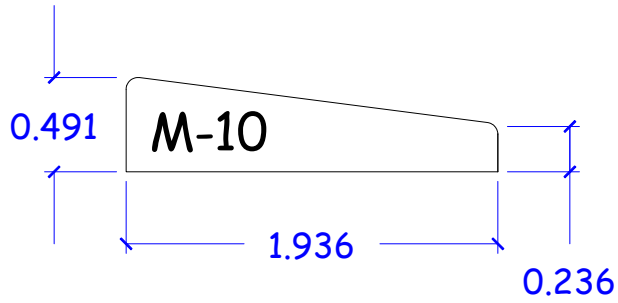

MISC. Patterns

M-20, M

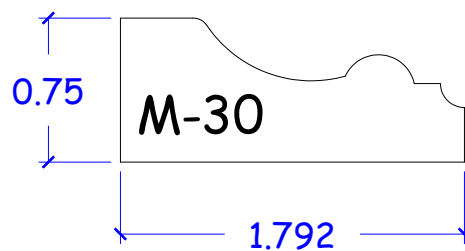
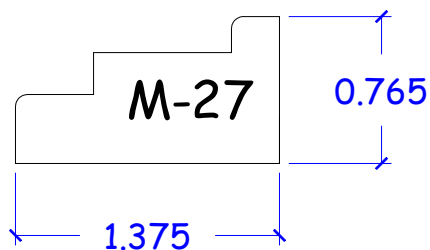
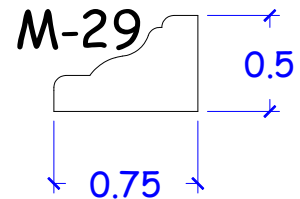
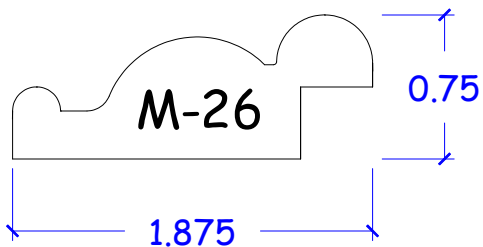
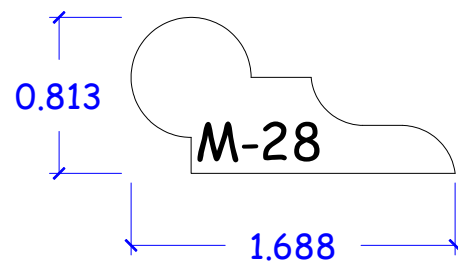
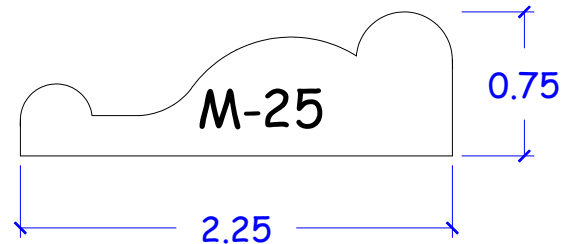
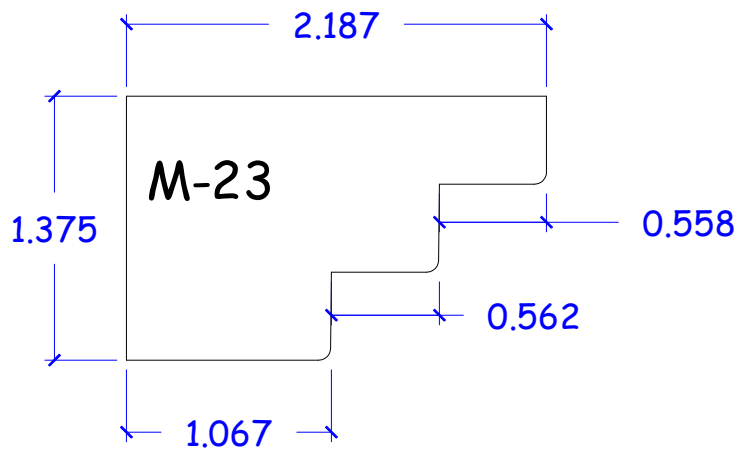
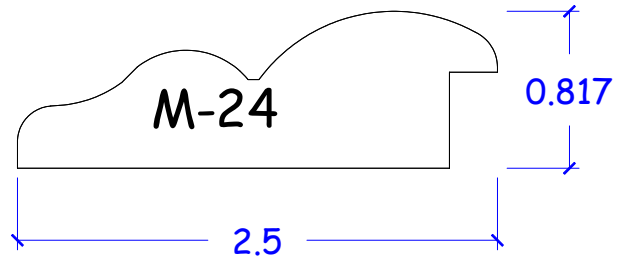
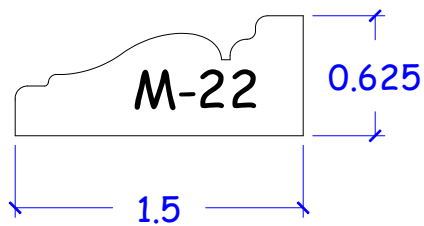
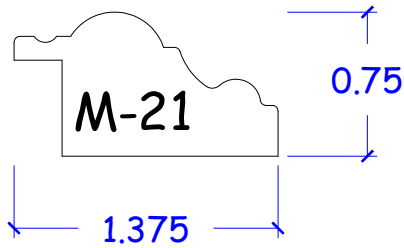
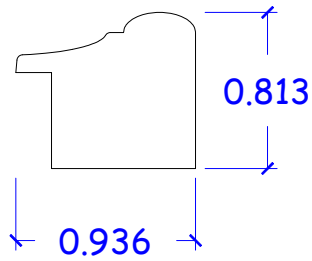

MISC. Patterns

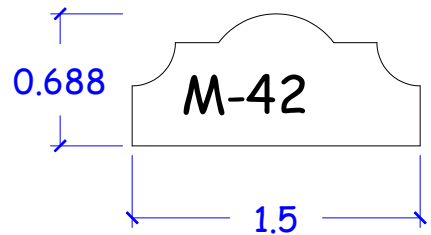
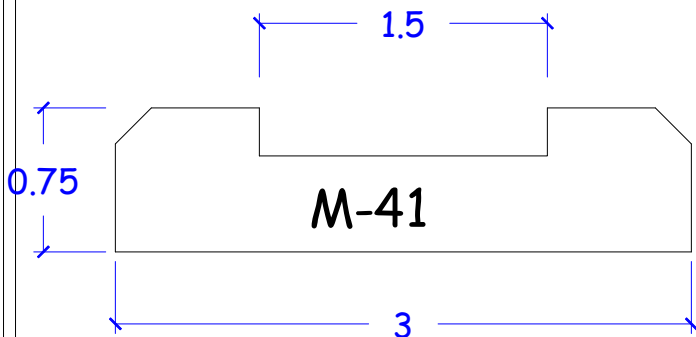
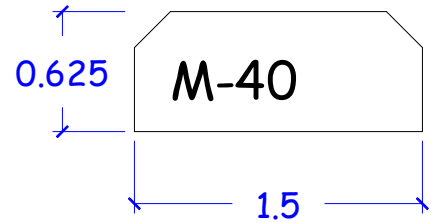
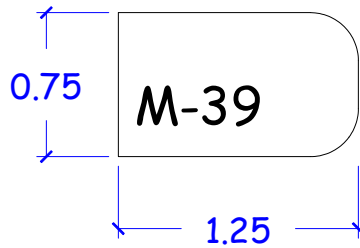
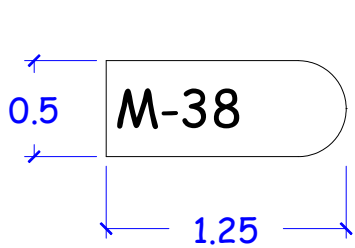
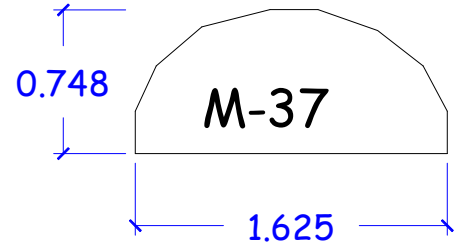
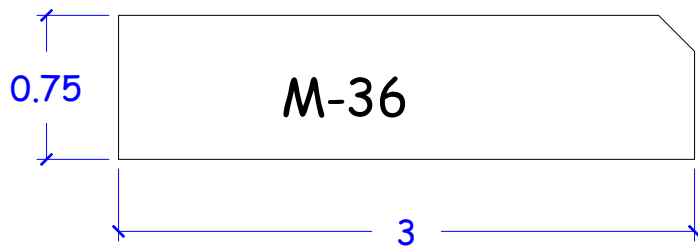
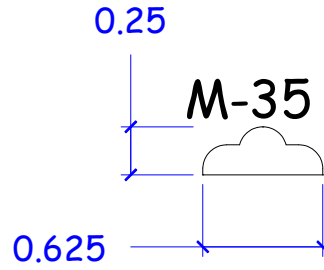
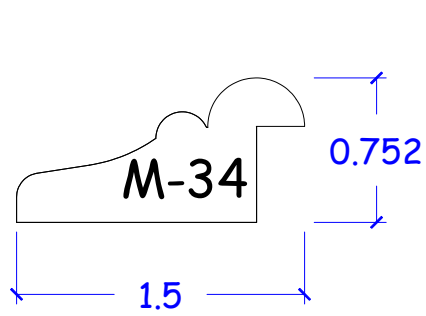
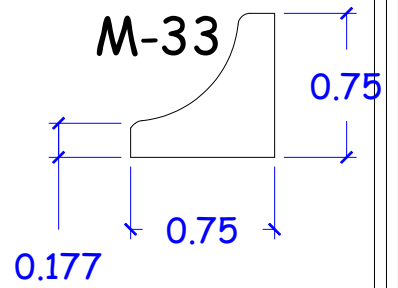
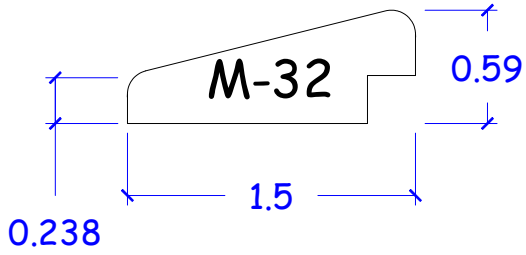
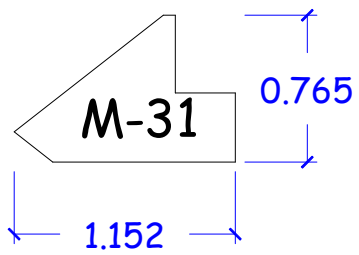

MISC. Patterns

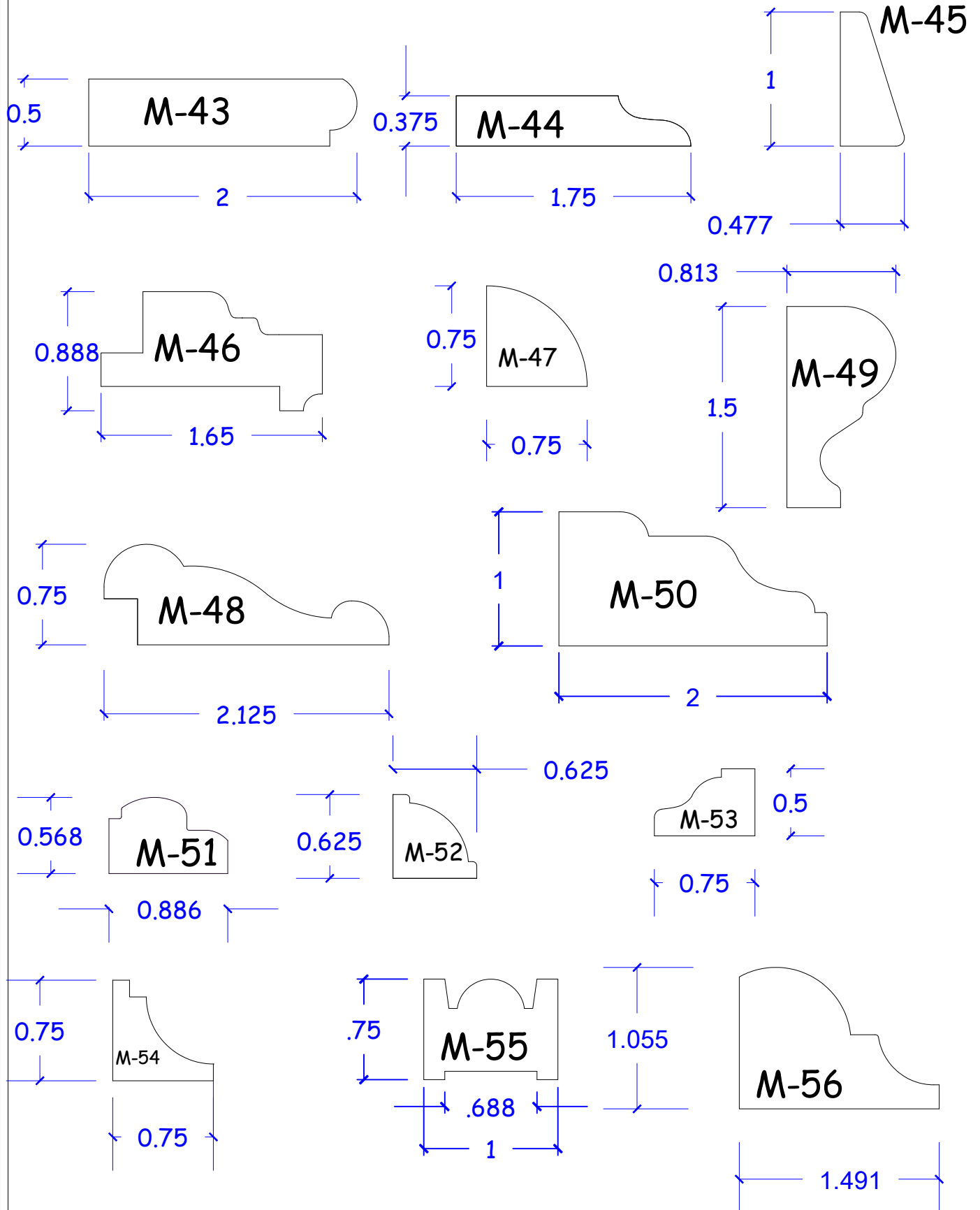

MISC. Patterns

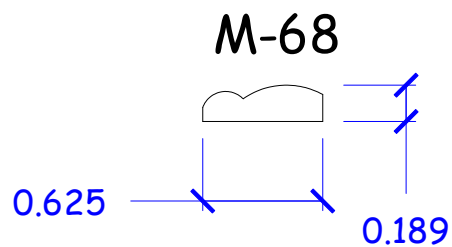
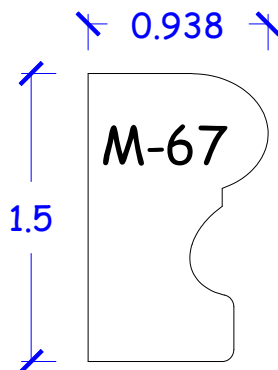
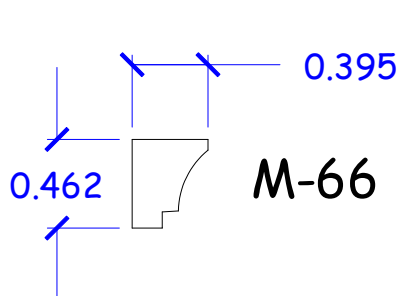
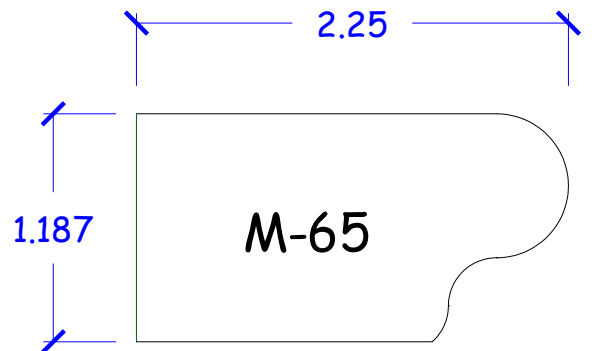
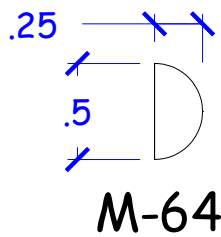
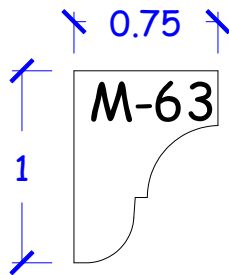
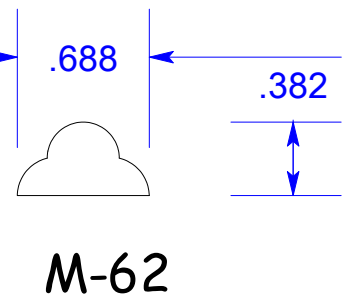
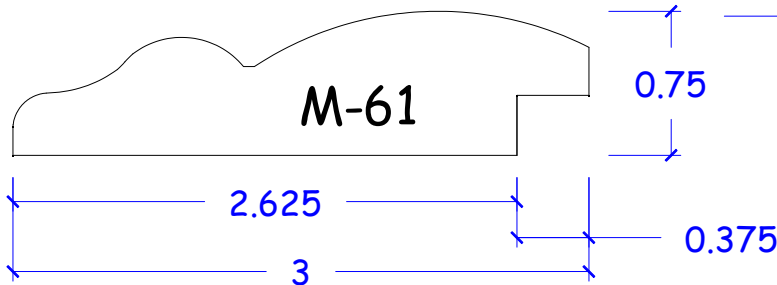
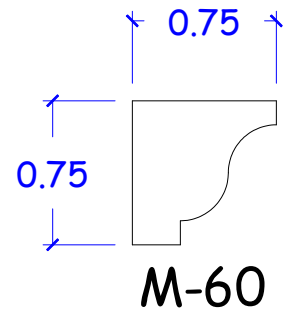
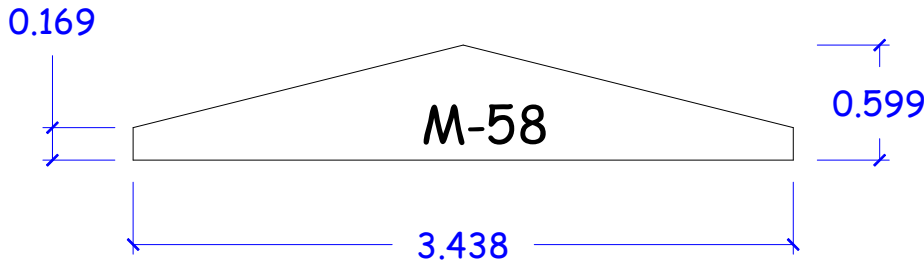
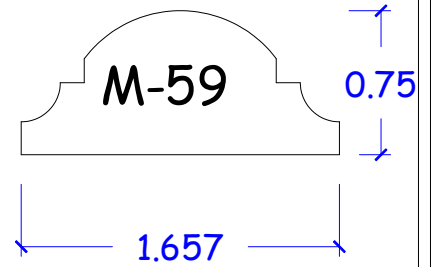
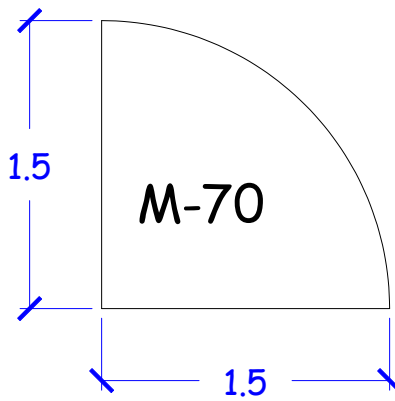
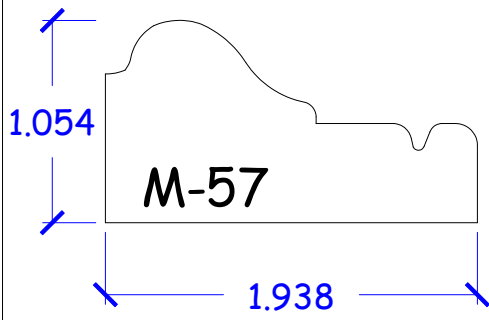

MISC. Patterns

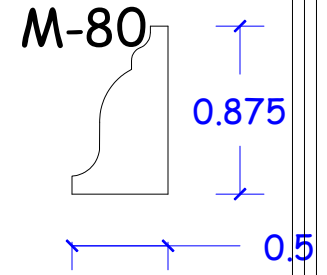
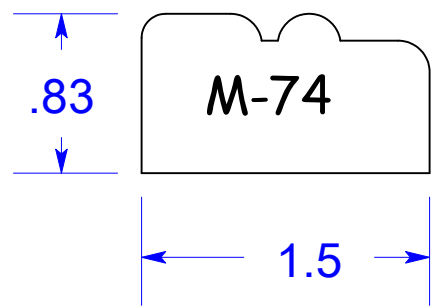
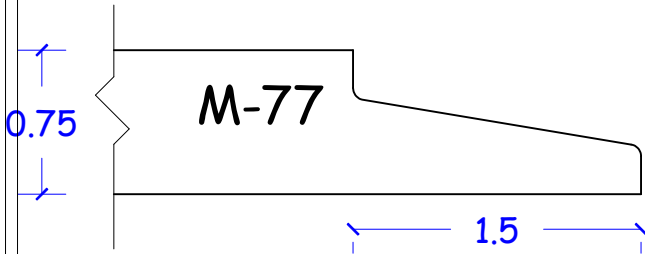
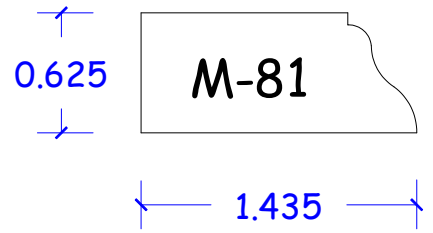
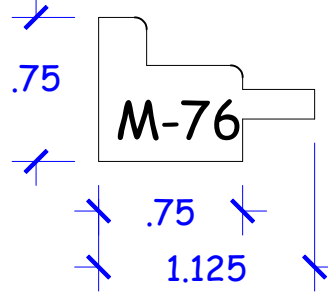
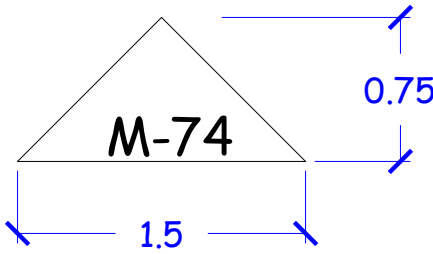
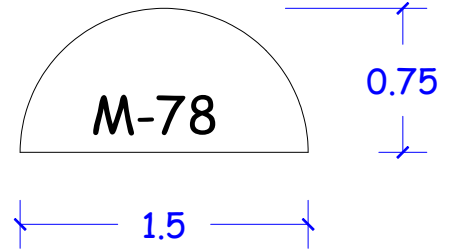
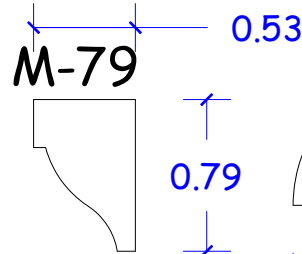
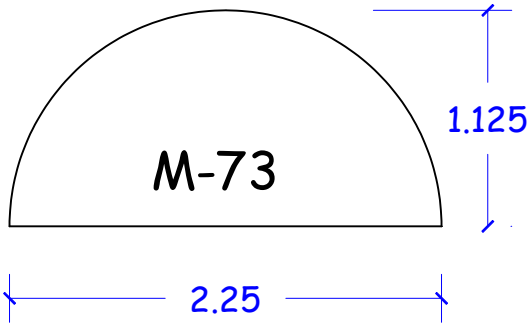
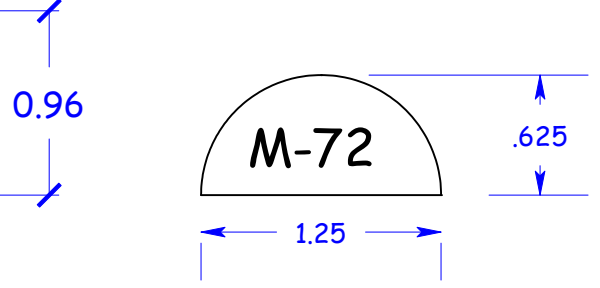
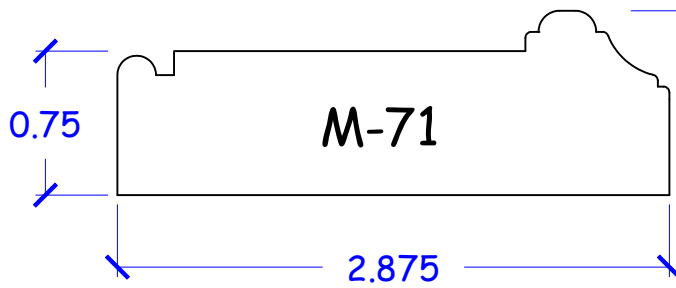
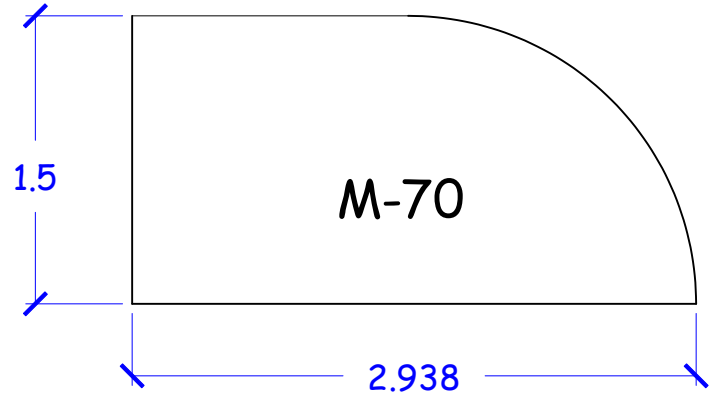
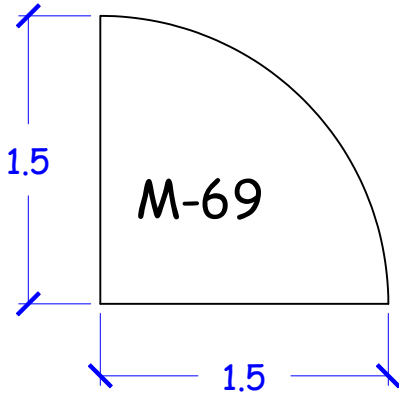

MISC. Patterns

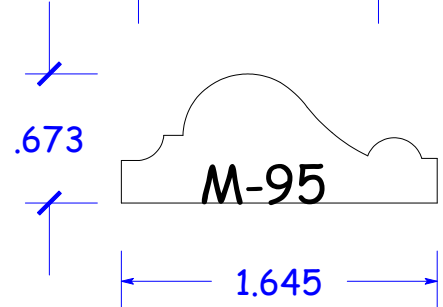
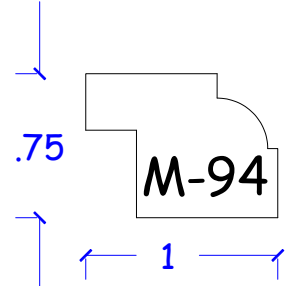
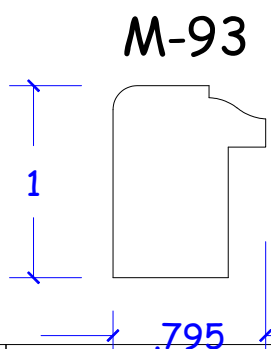
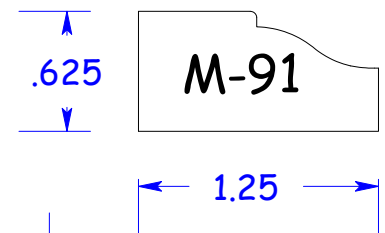
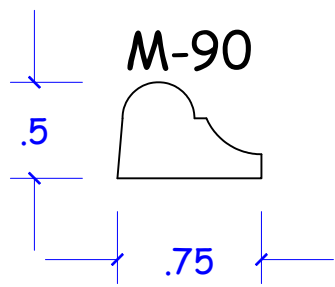
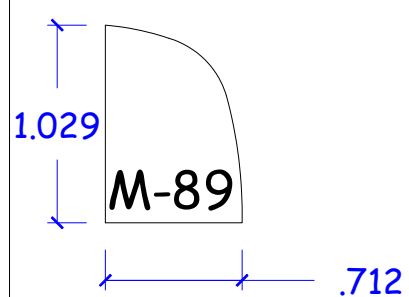
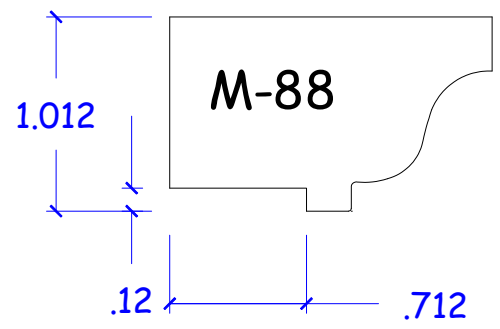
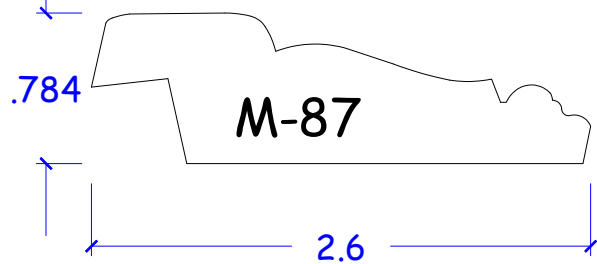
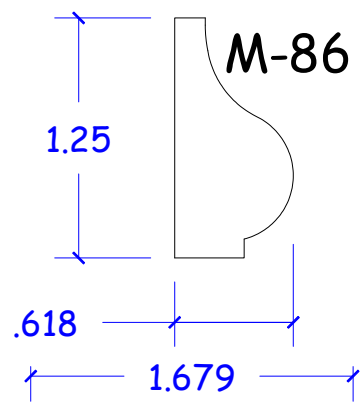
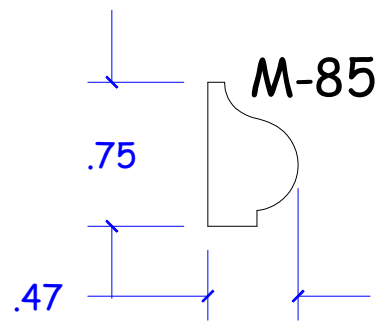
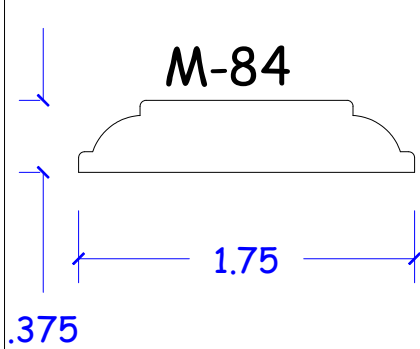
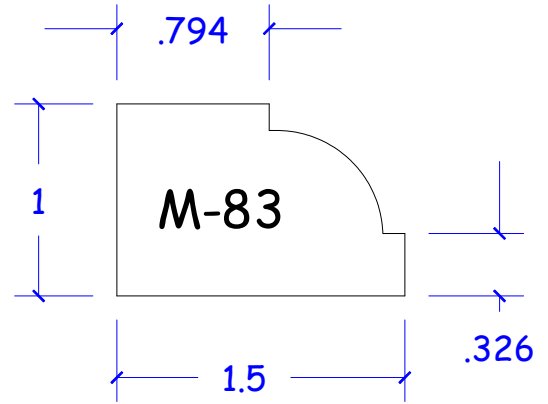
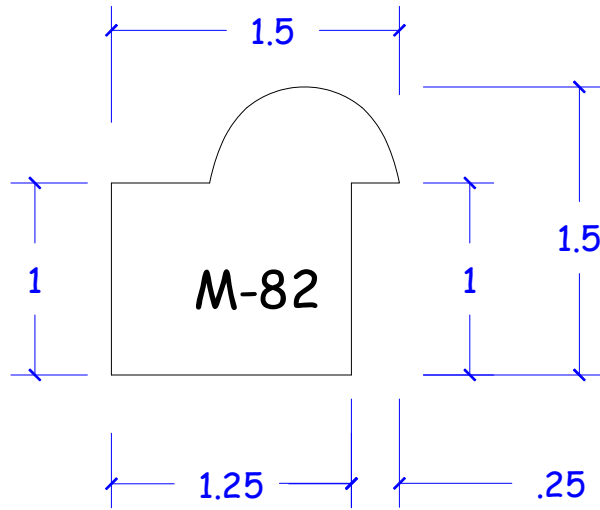

MISC. Patterns

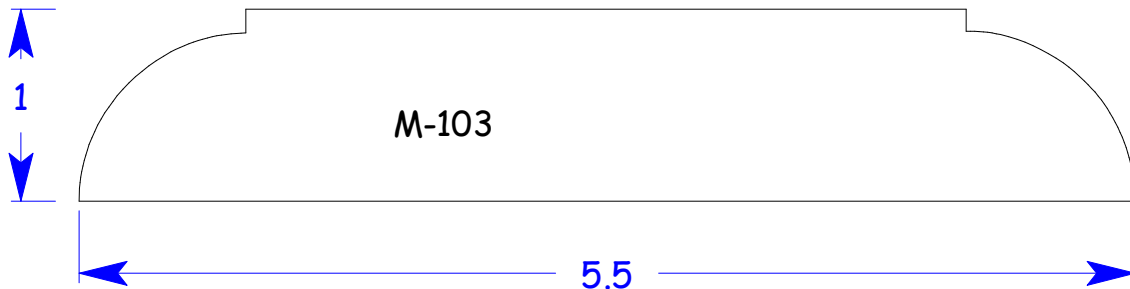
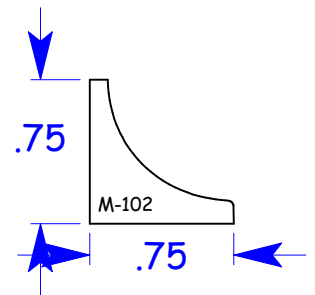
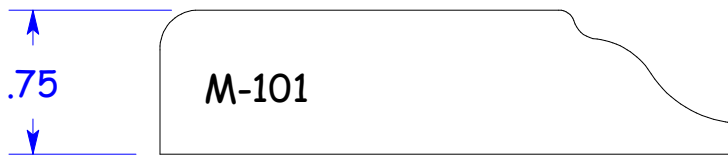
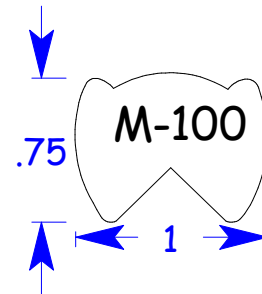
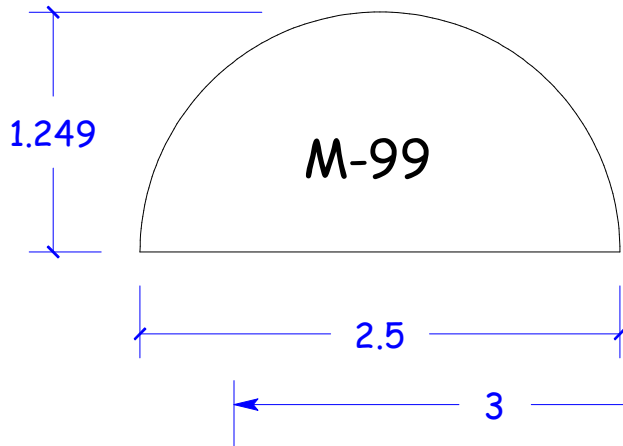
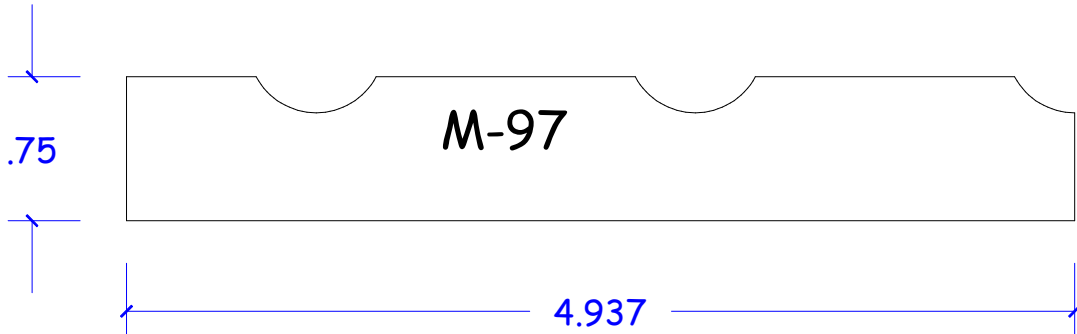
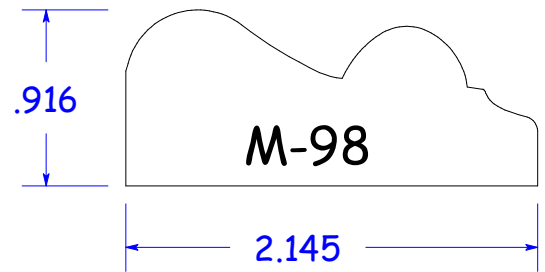
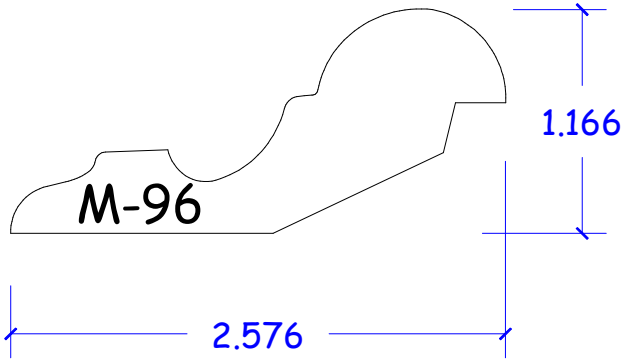

MISC. Patterns

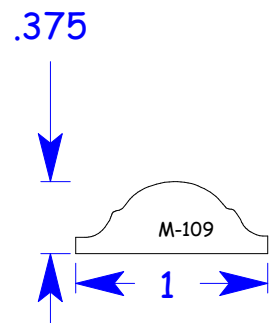
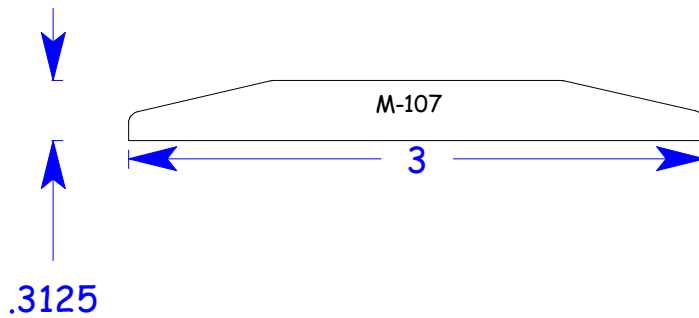
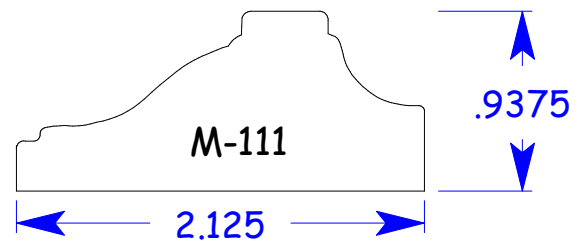
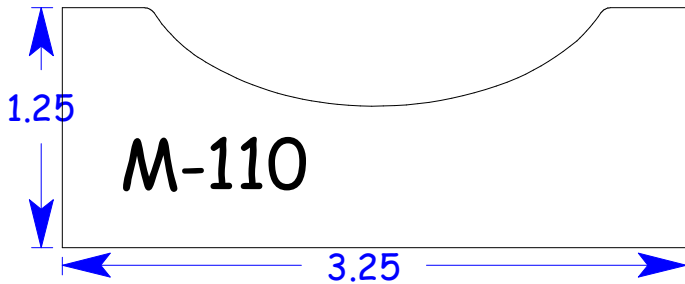
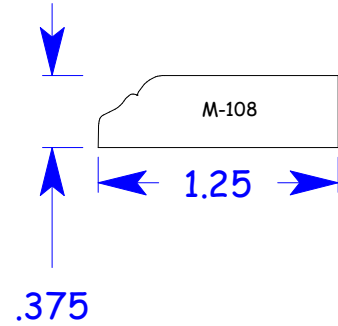
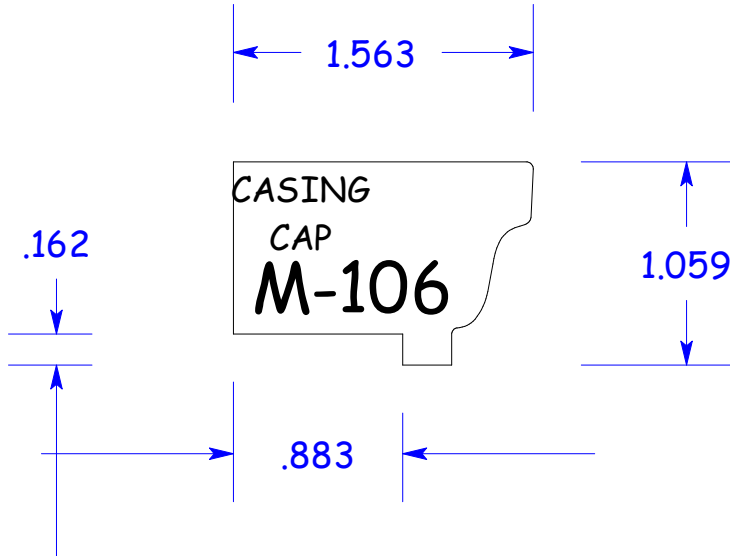
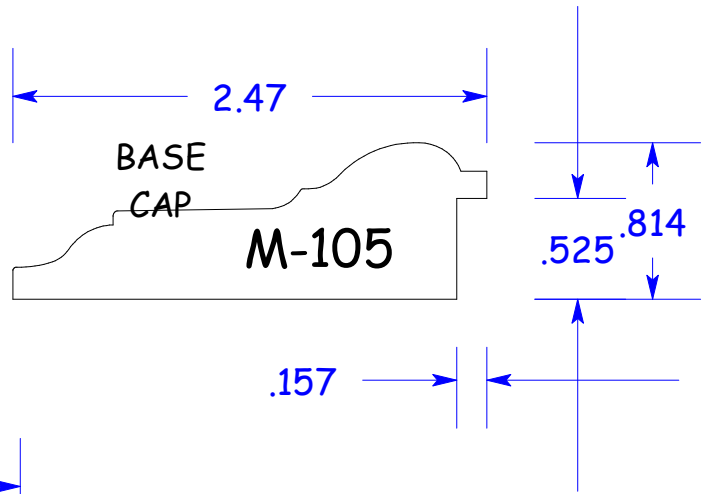
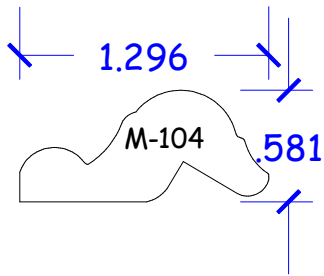

MISC. Patterns

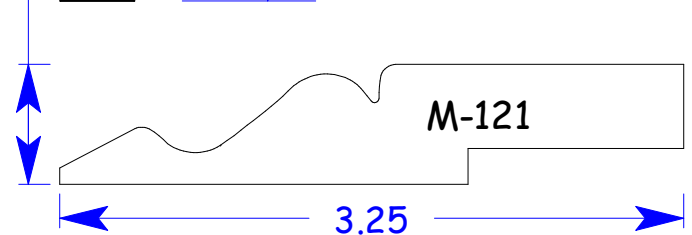
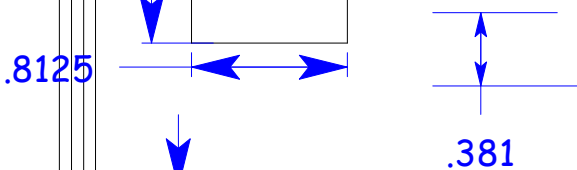
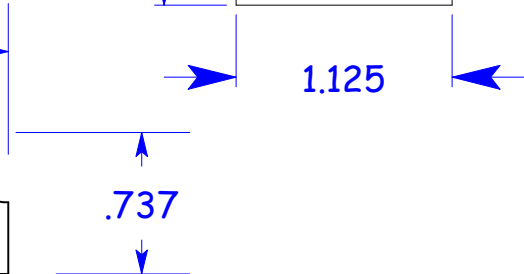
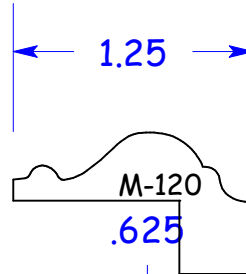
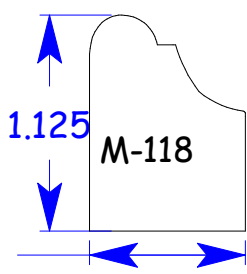
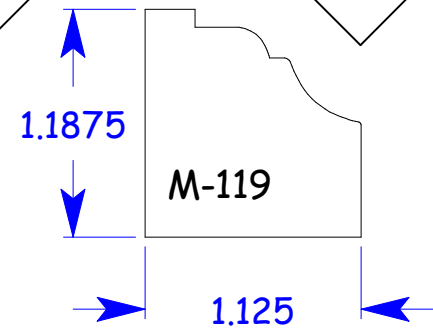
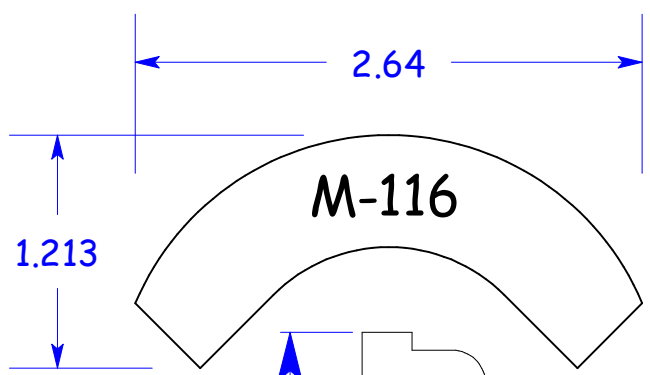
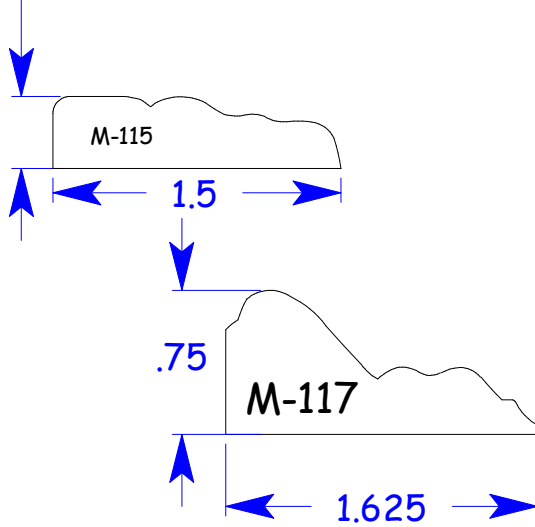
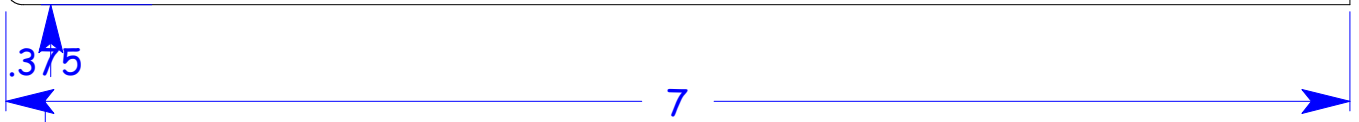
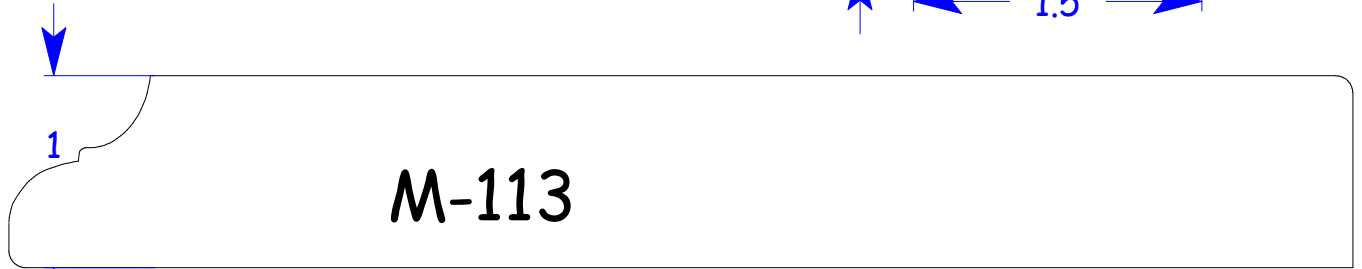
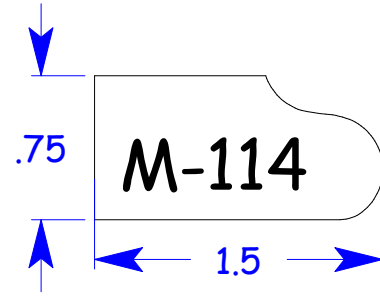
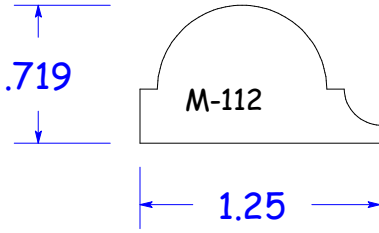

MISC. Patterns

