

Casing Patterns

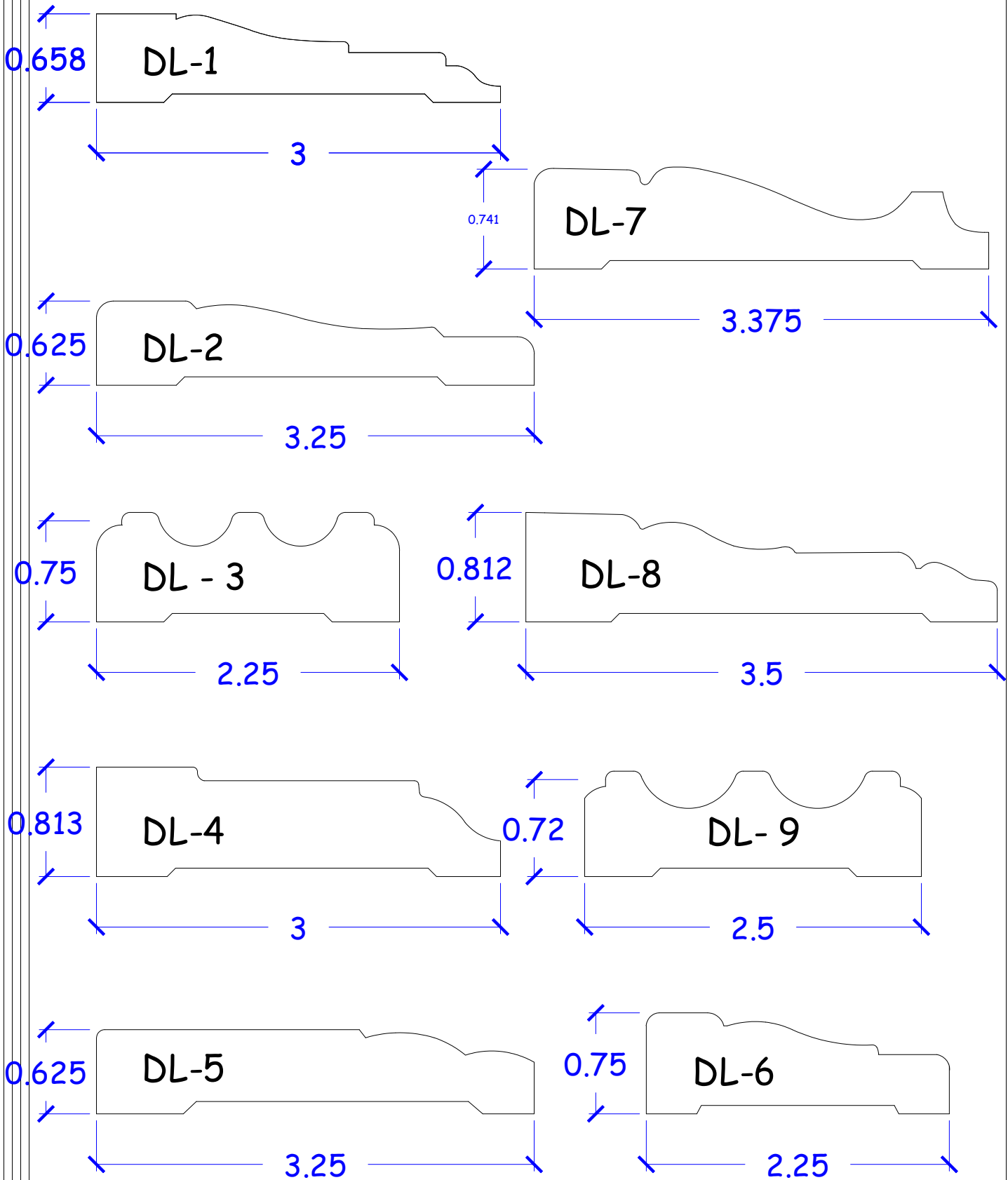

Casing Patterns

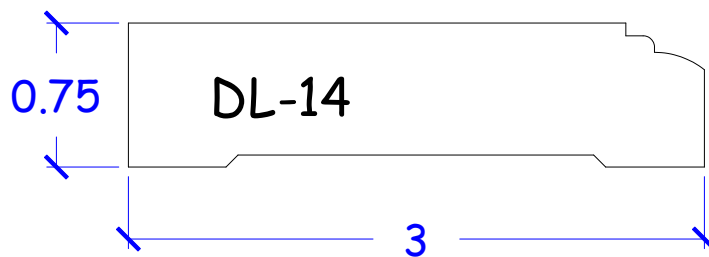
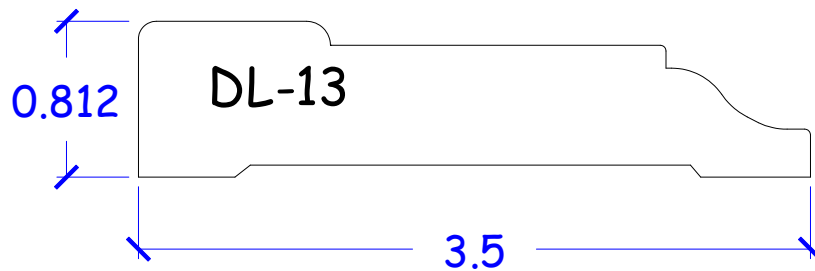
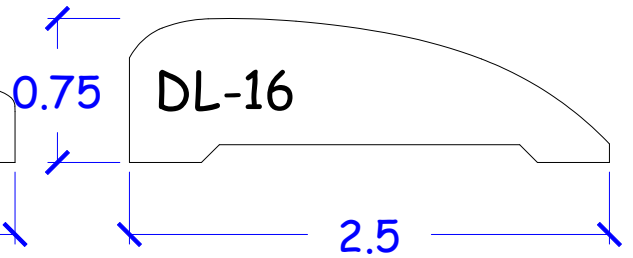
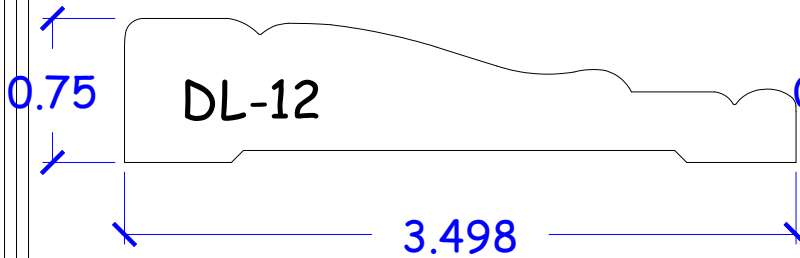
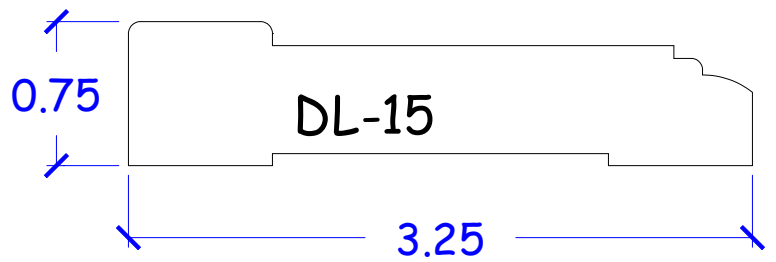
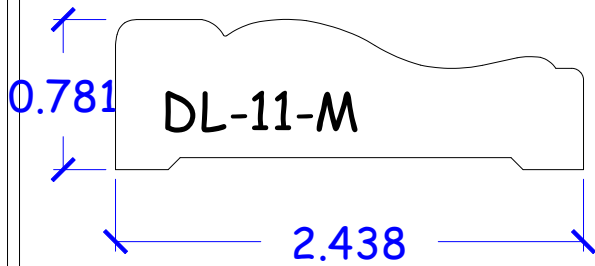
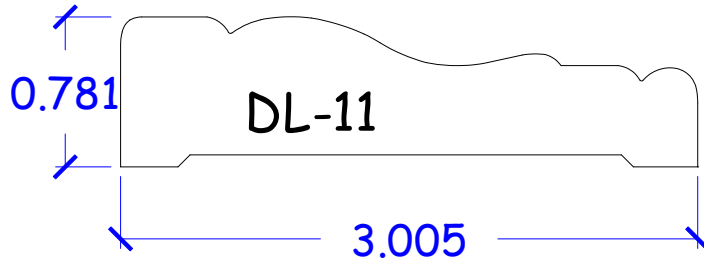
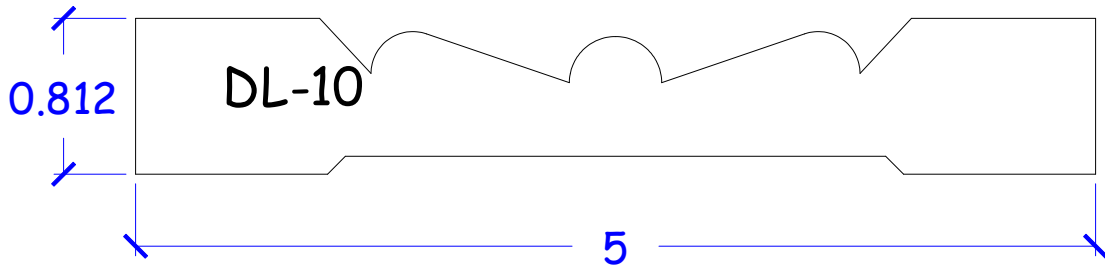

Casing Patterns

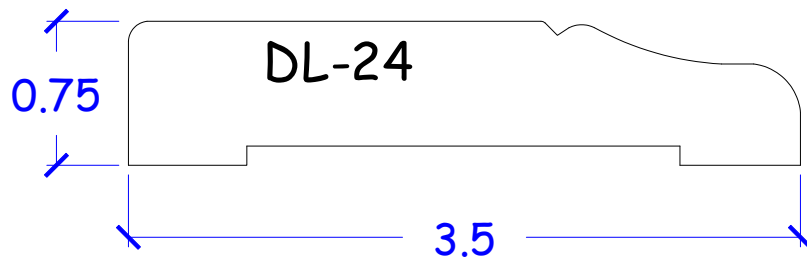
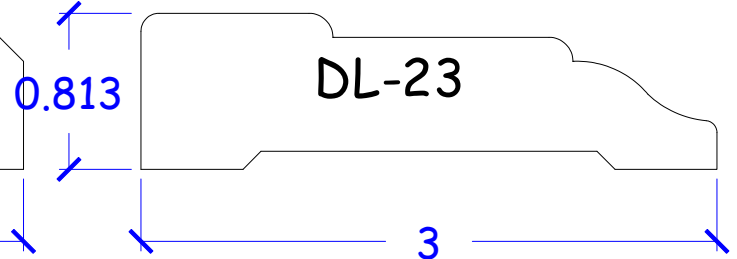
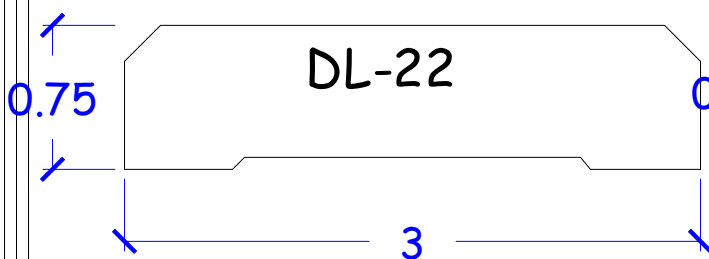
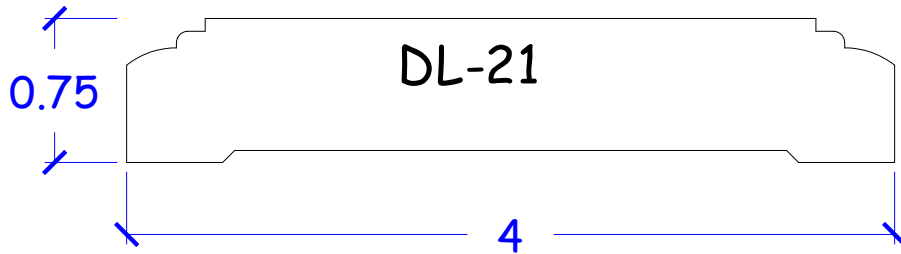
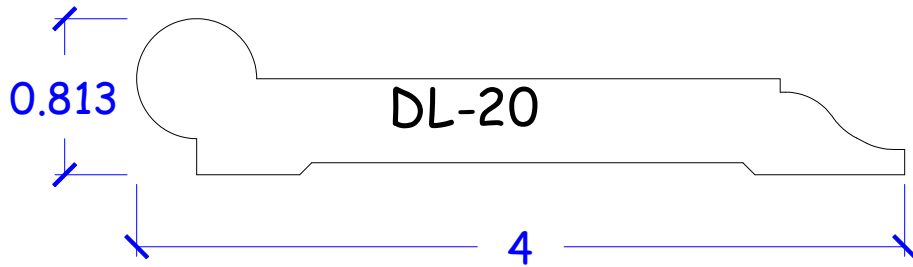
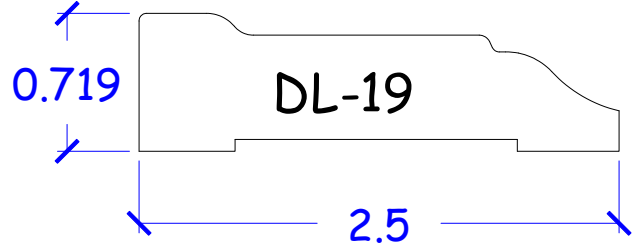
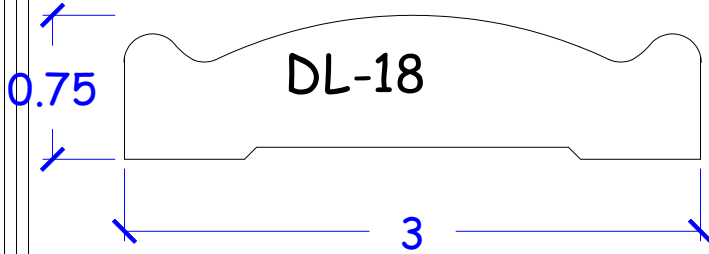
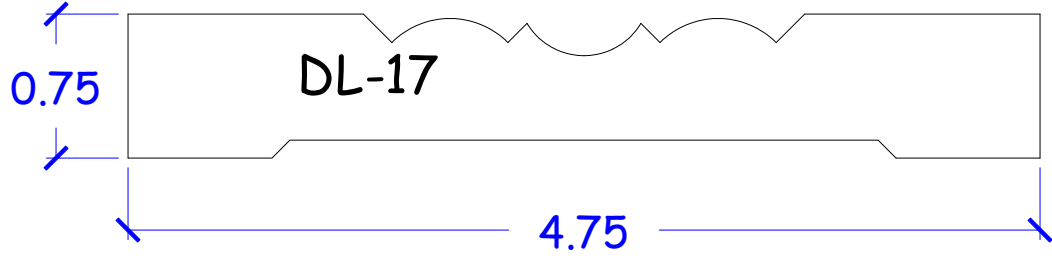

Casing Patterns

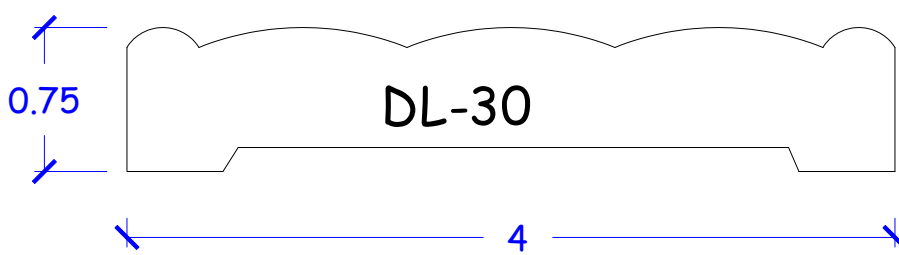
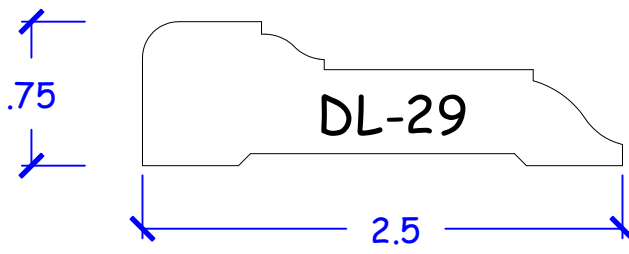
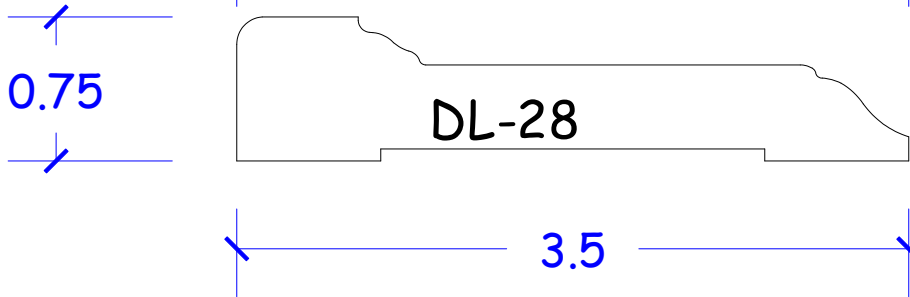
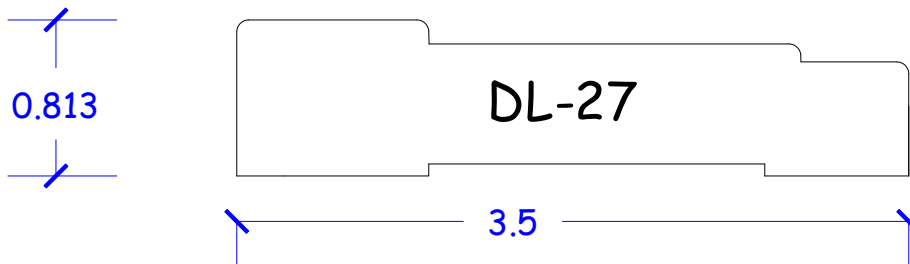
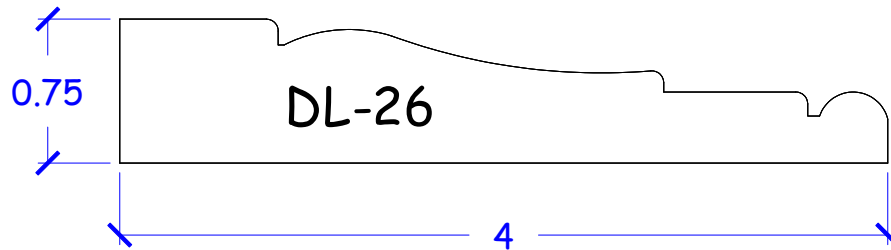
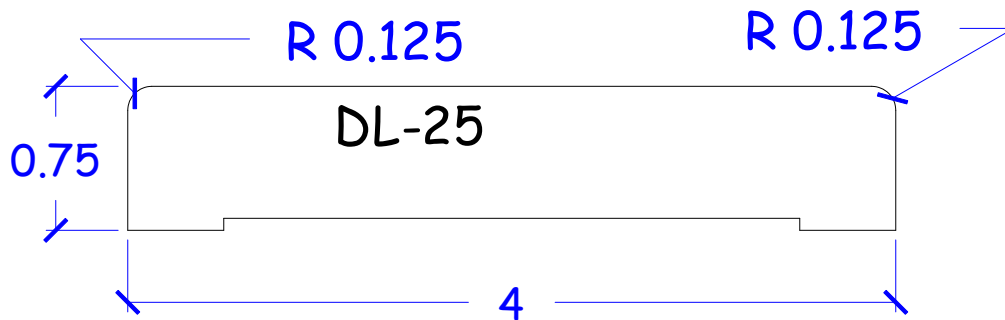

Casing Patterns

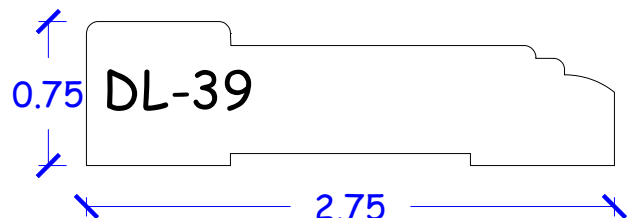
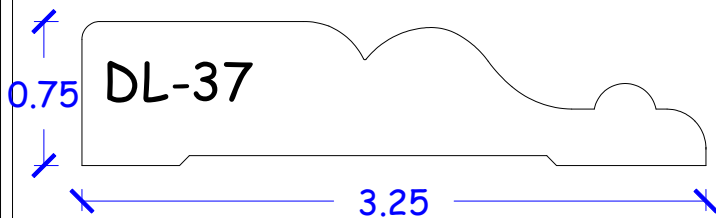
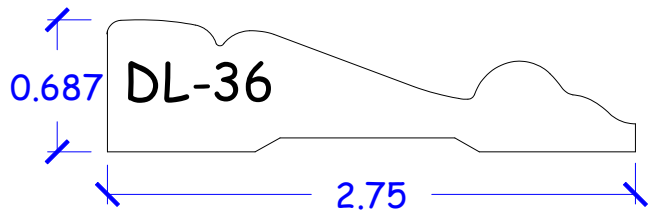
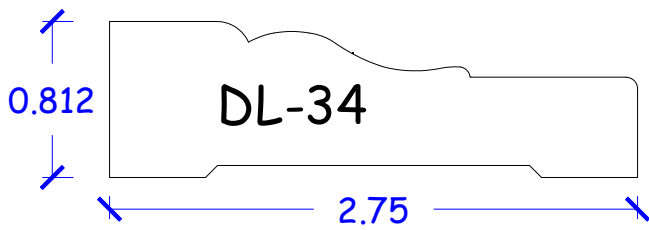
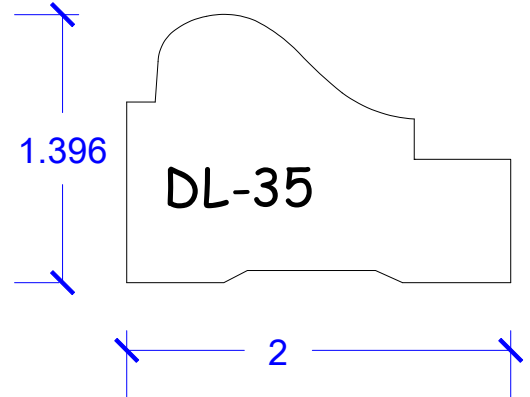
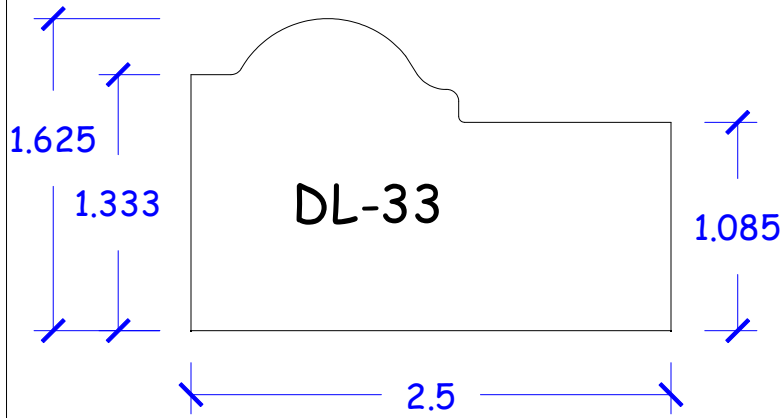
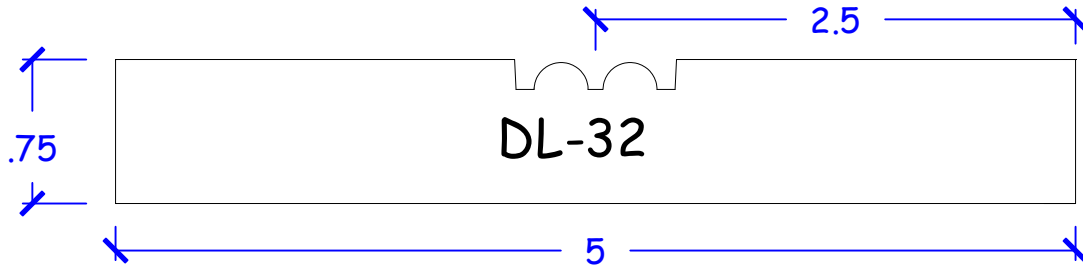
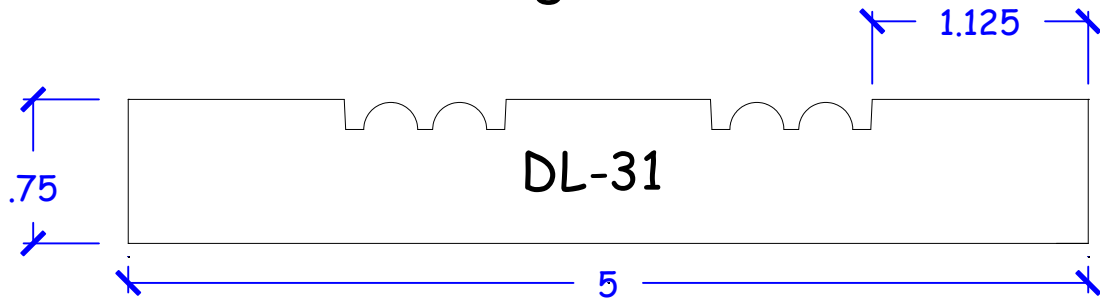

Casing Patterns

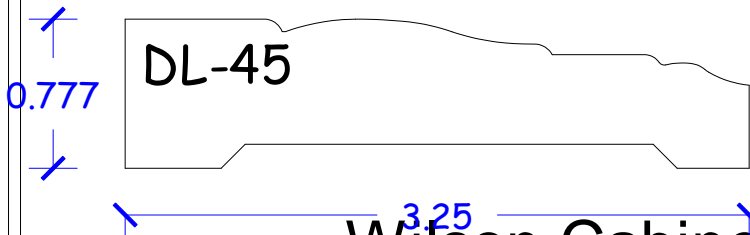
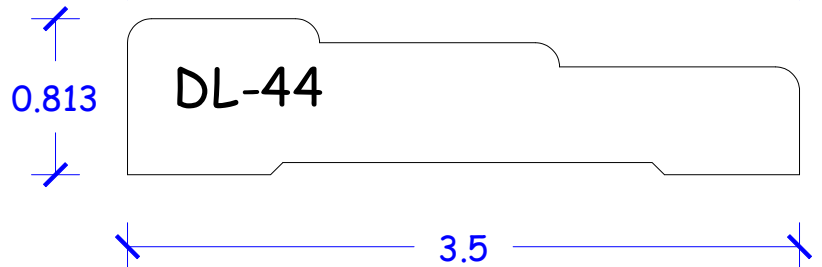
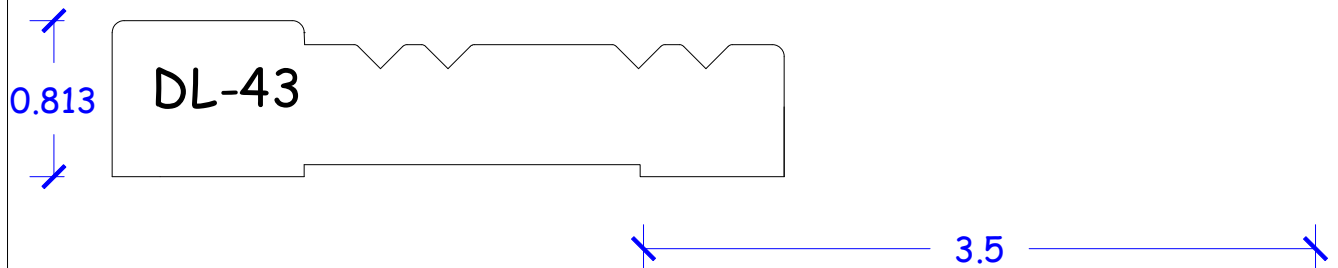
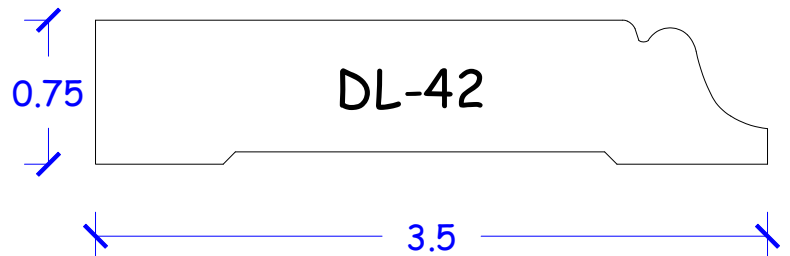
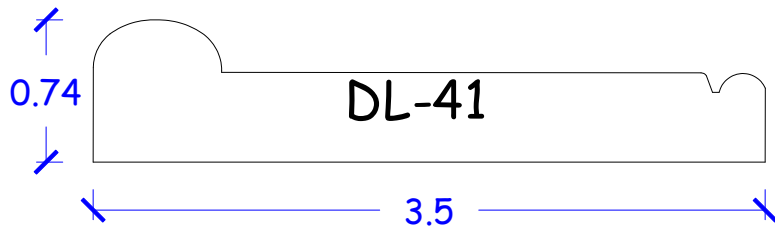
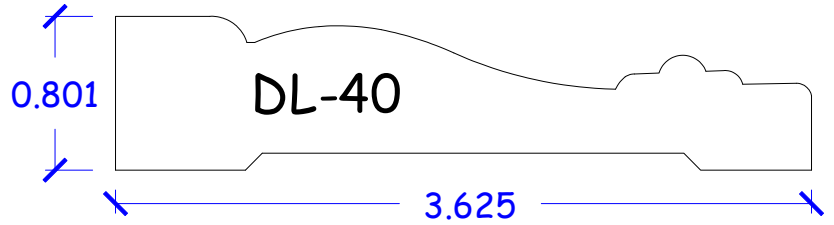
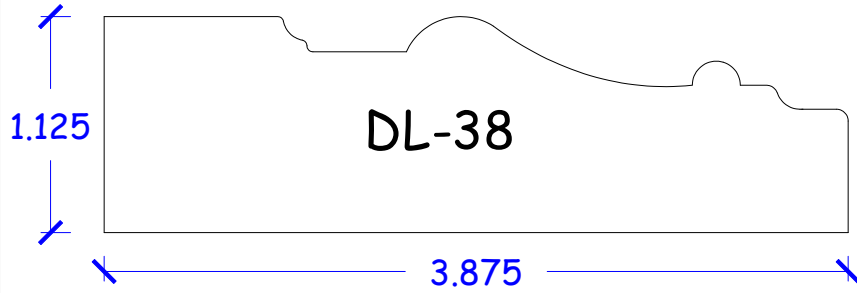

Casing Patterns

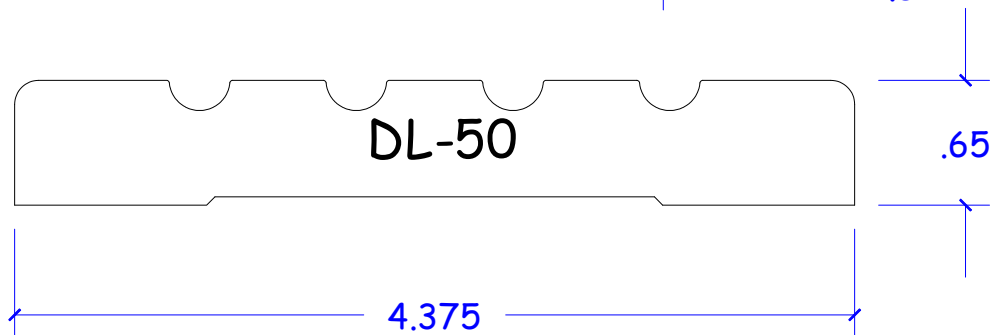
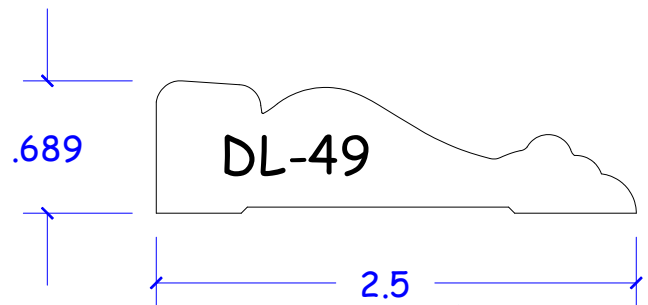
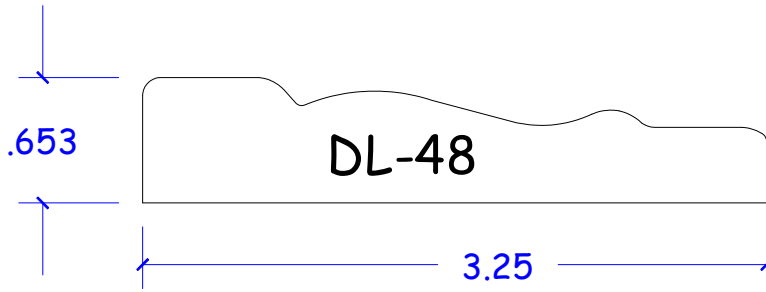
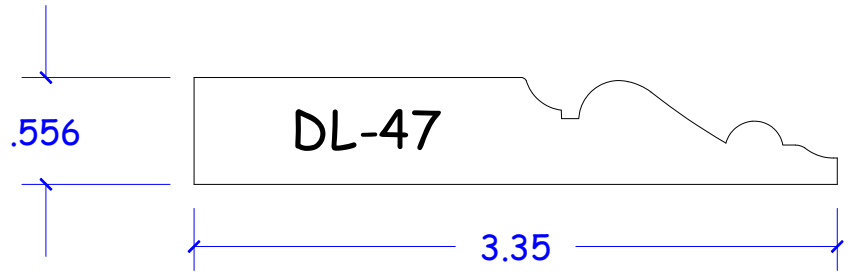
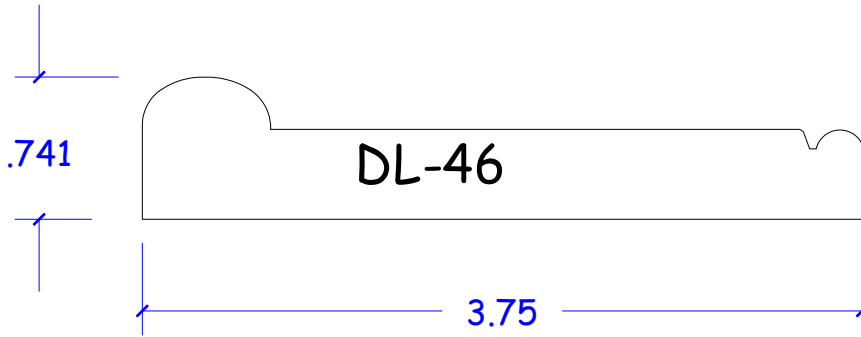

Casing Patterns

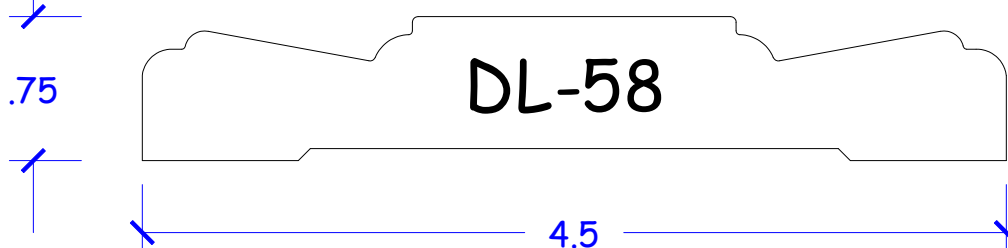
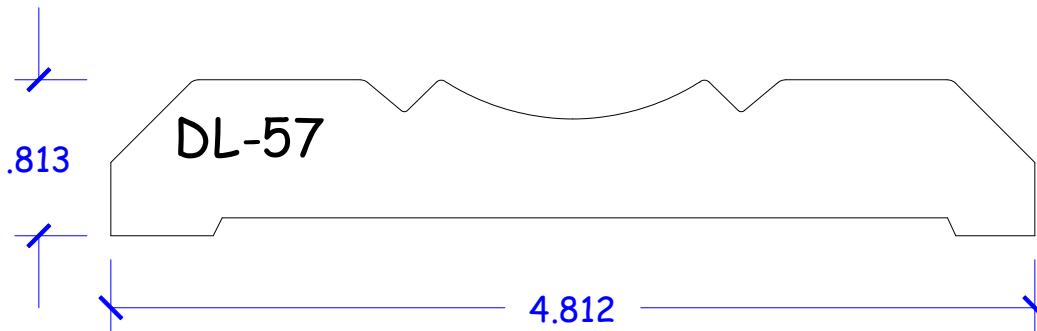
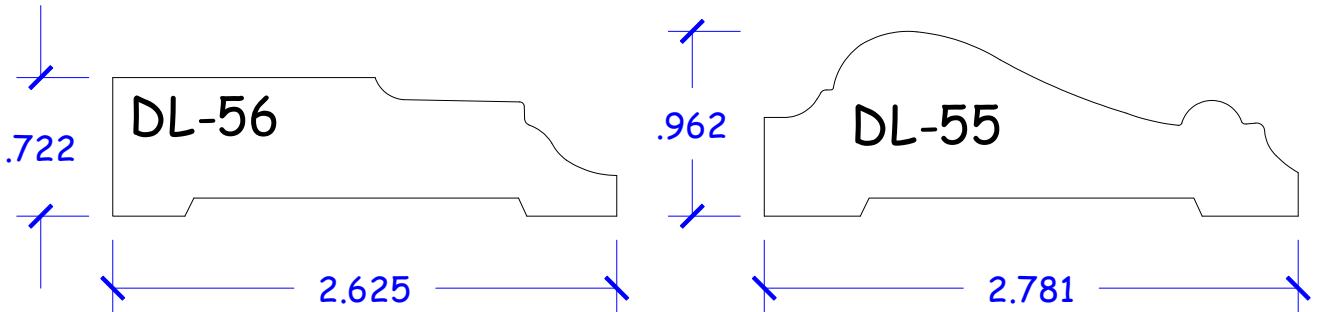
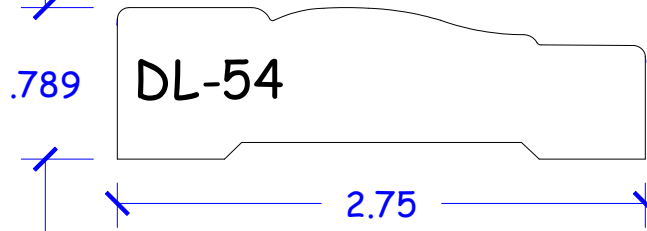
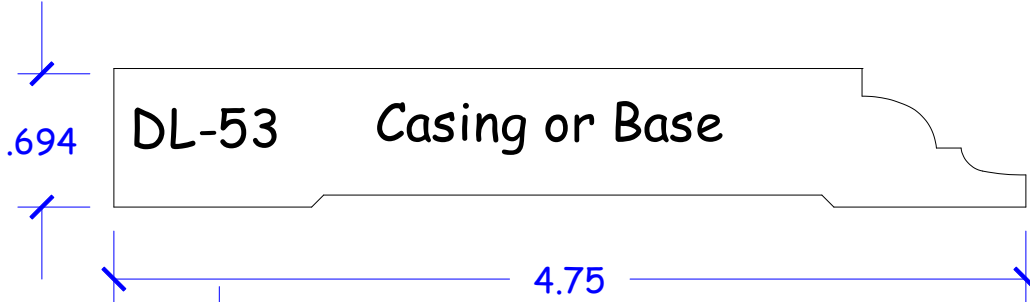
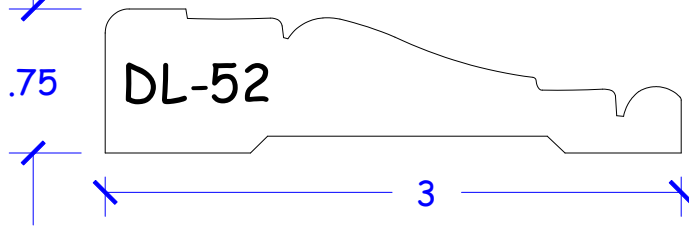

Casing Patterns

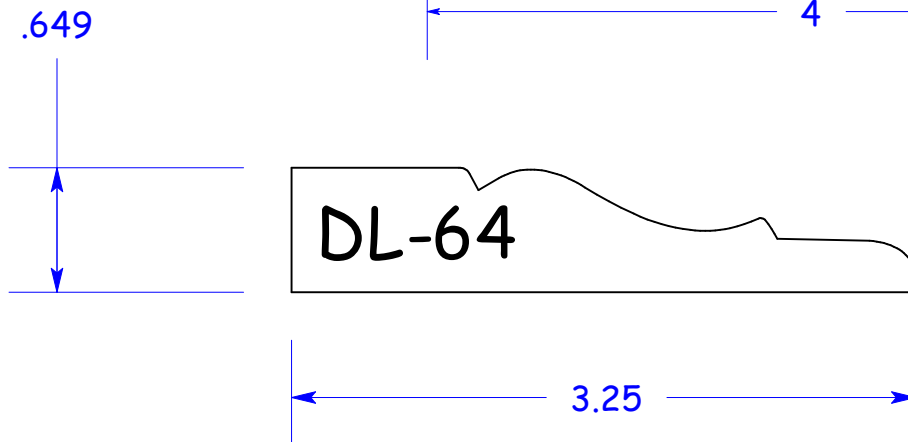
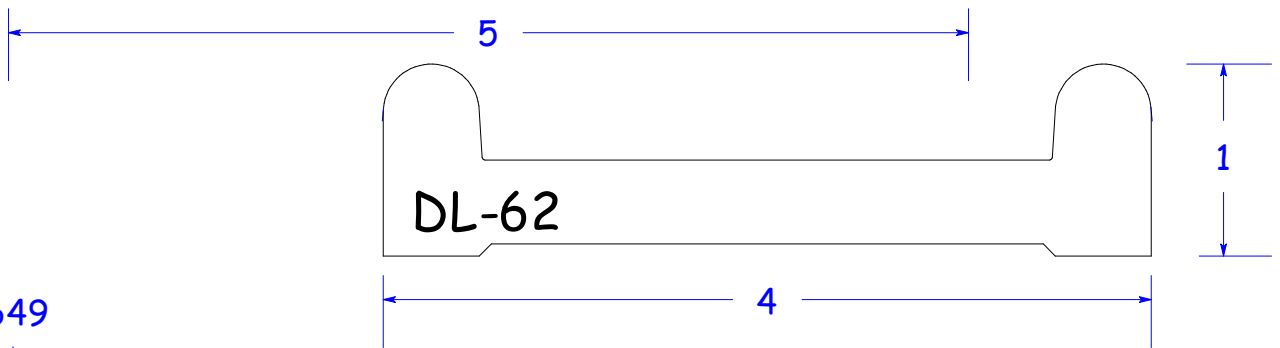
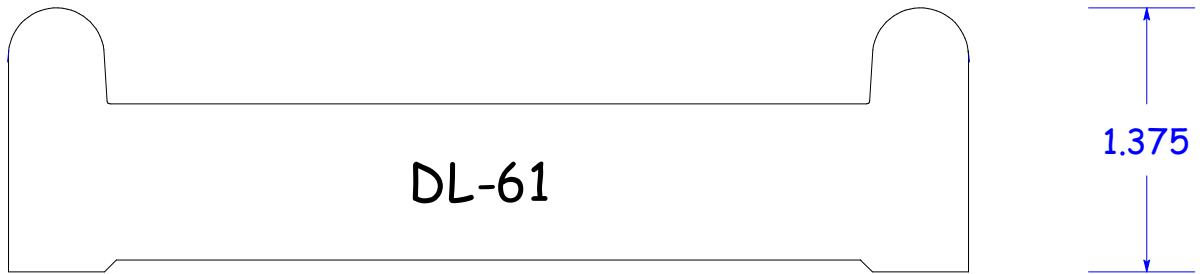
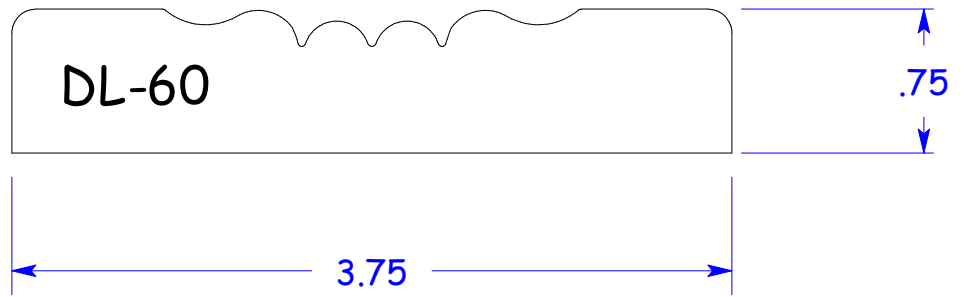
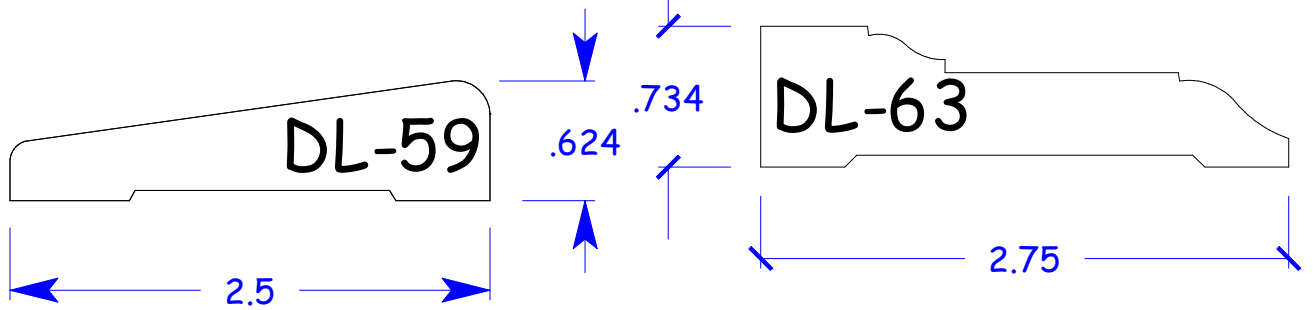

Casing Patterns

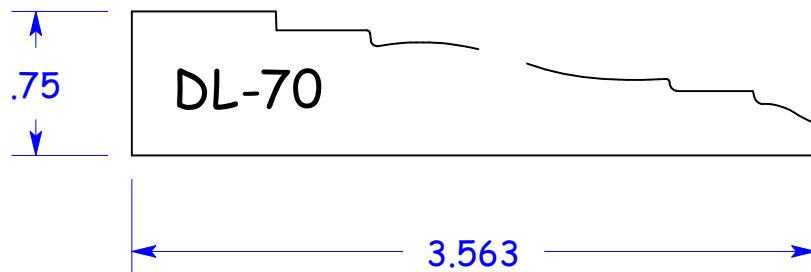
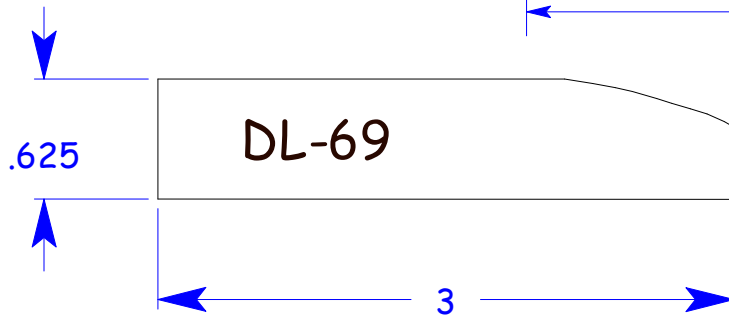
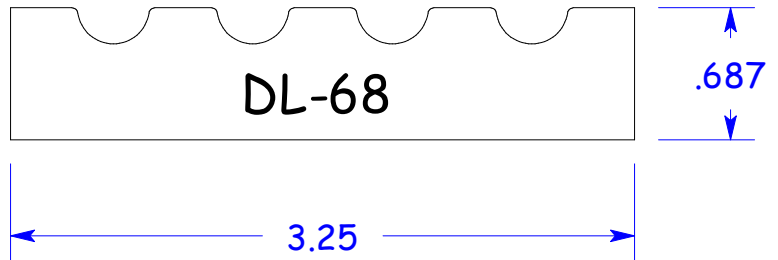
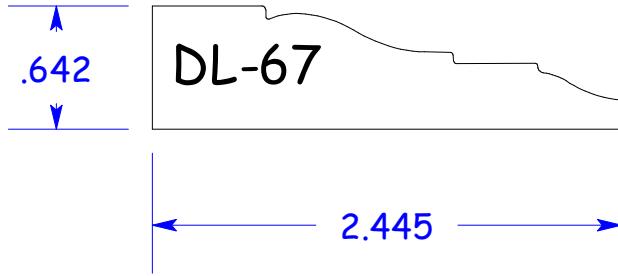
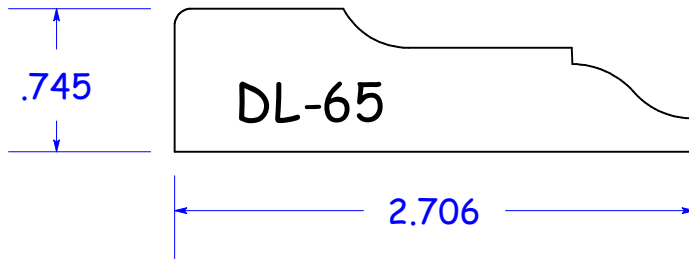

Casing Patterns

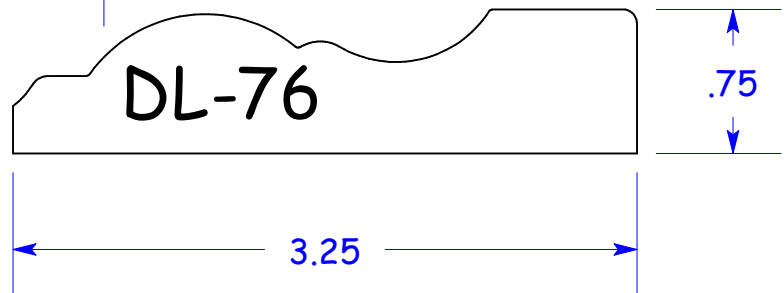
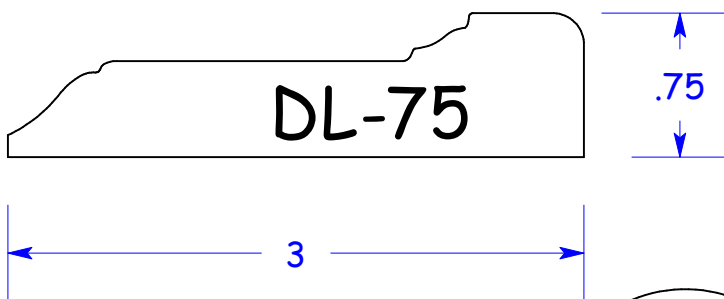
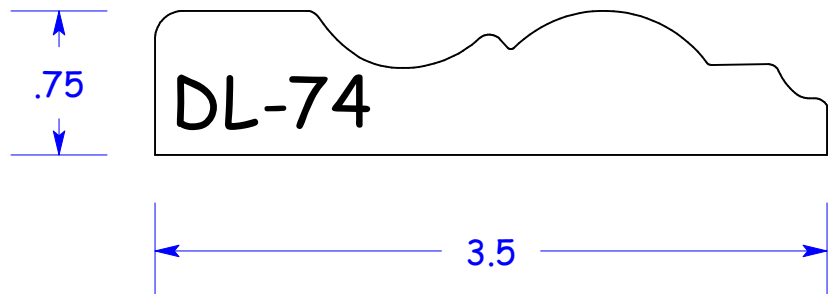
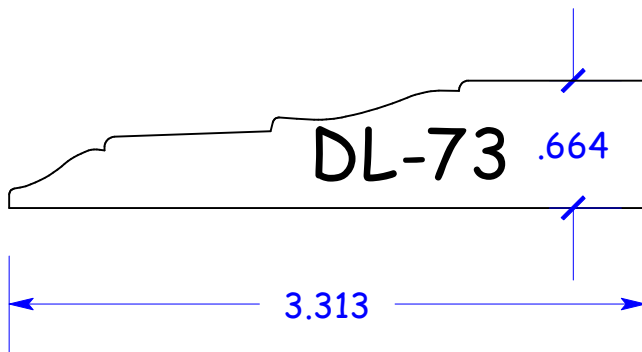
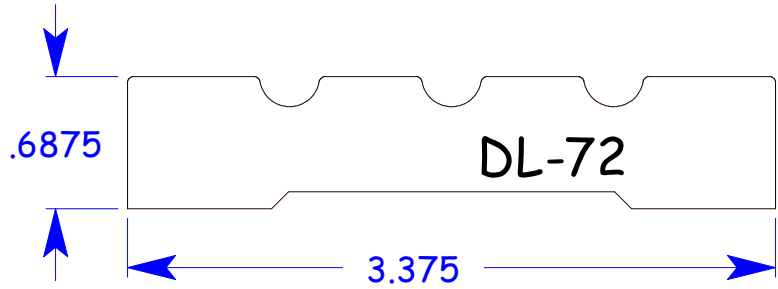
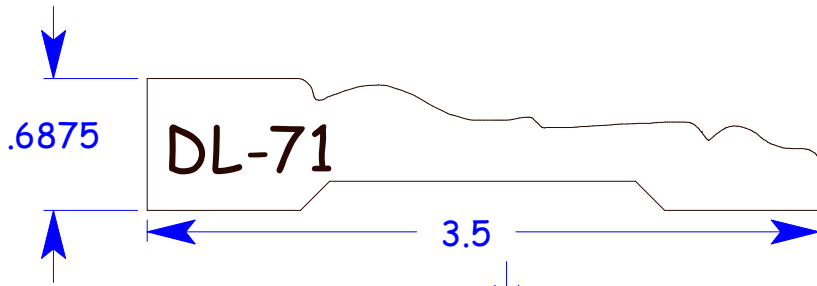

Casing Patterns

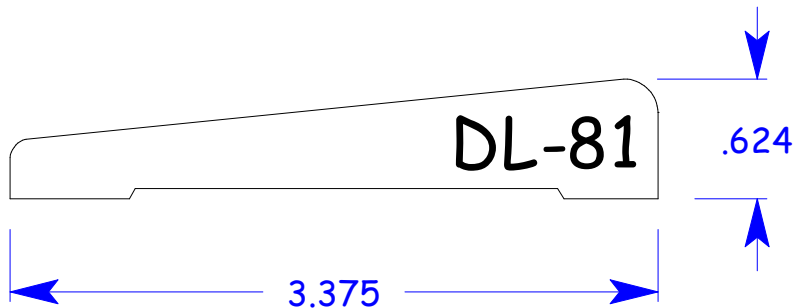
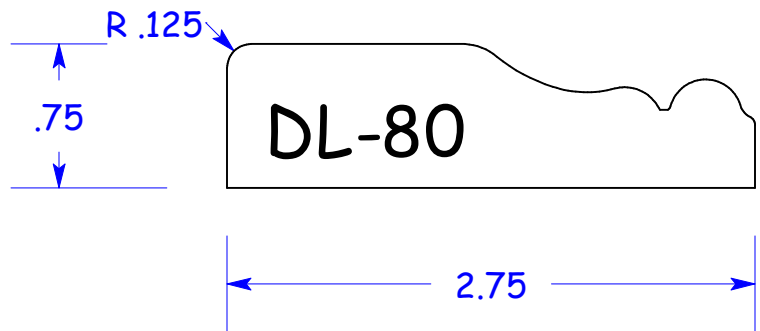
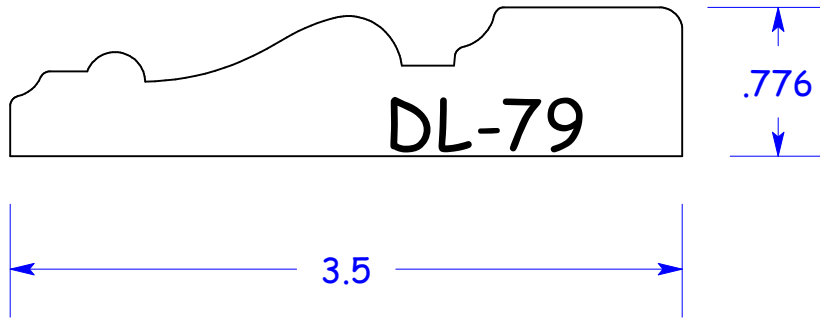
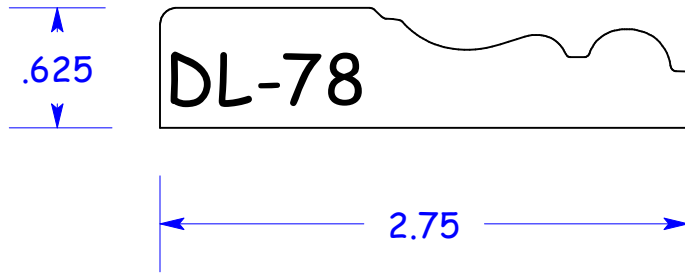
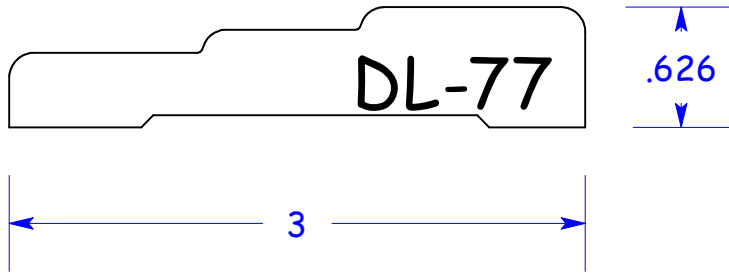

Casing Patterns

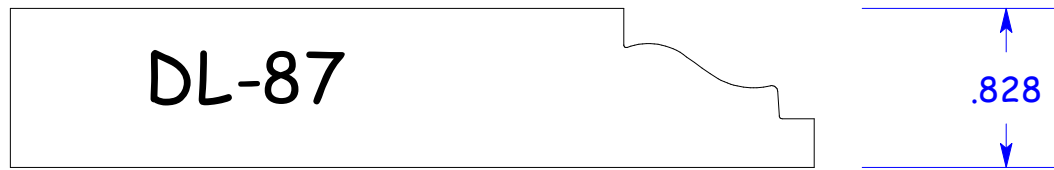
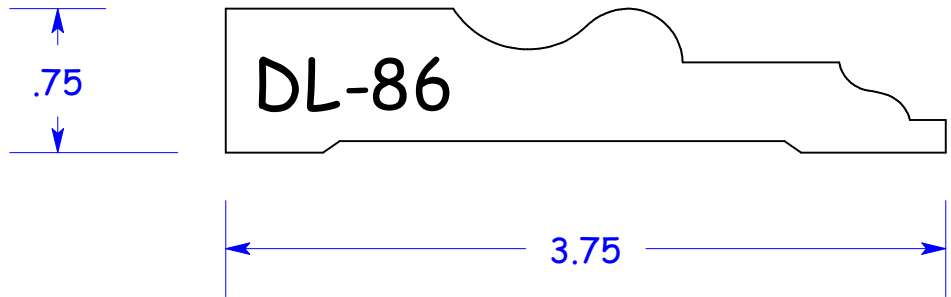
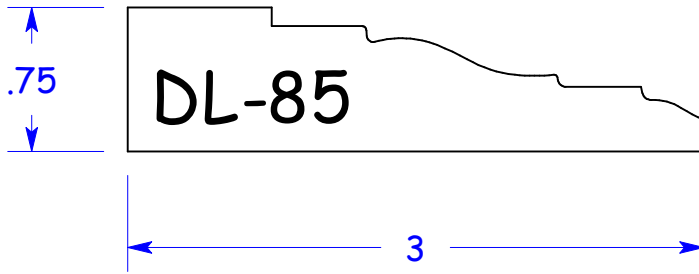
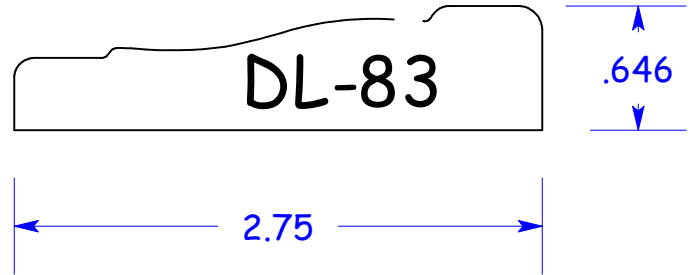
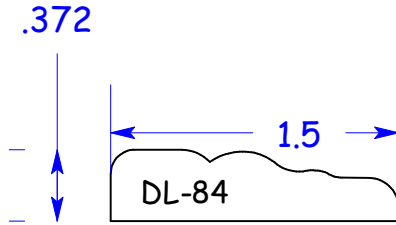
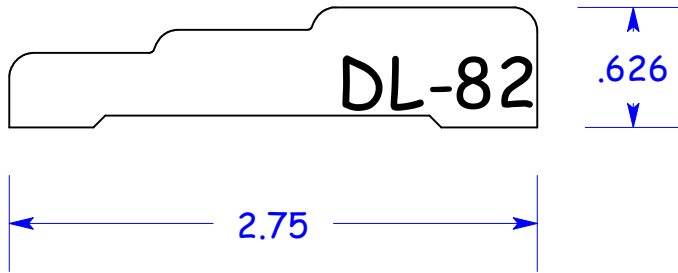

Casing Patterns

