



# Moulding Patterns

(in stock knife patterns)

**Wilson Cabinetry, Inc.**

5046 Danford Dr  
Billings, MT 59106

(406) 652-4671 Phone  
(406) 652-1260 Fax

January 15, 2017

# Base Patterns

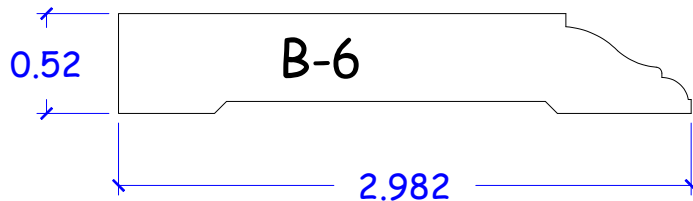
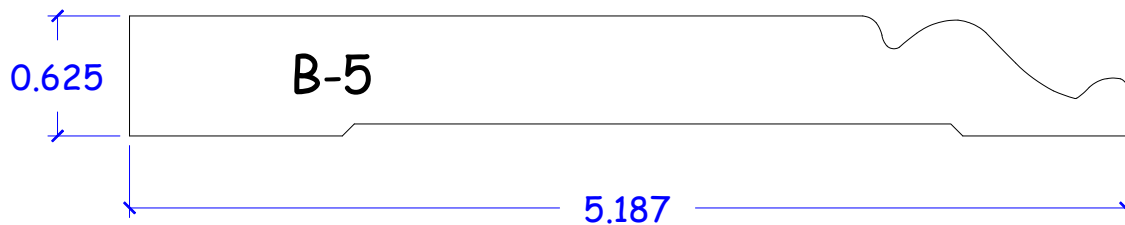
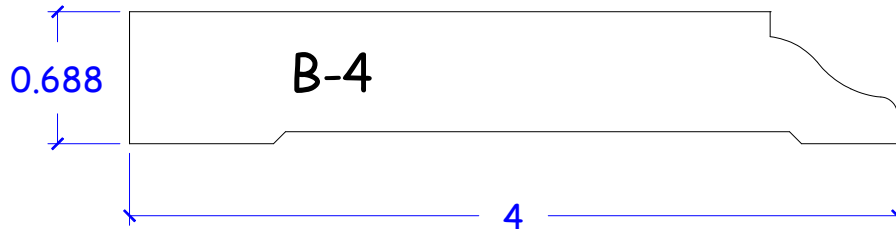
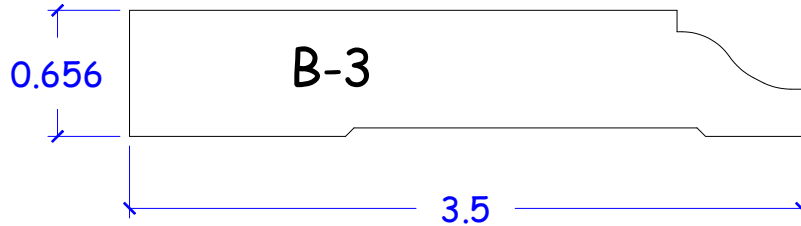
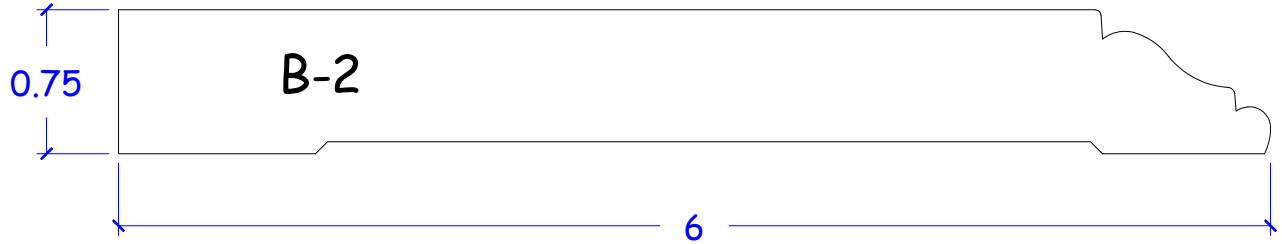
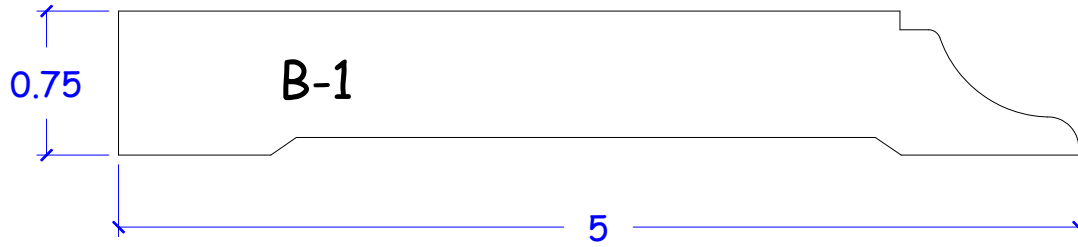

# Base Patterns

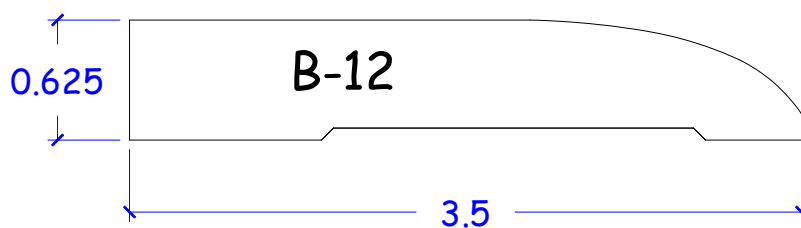
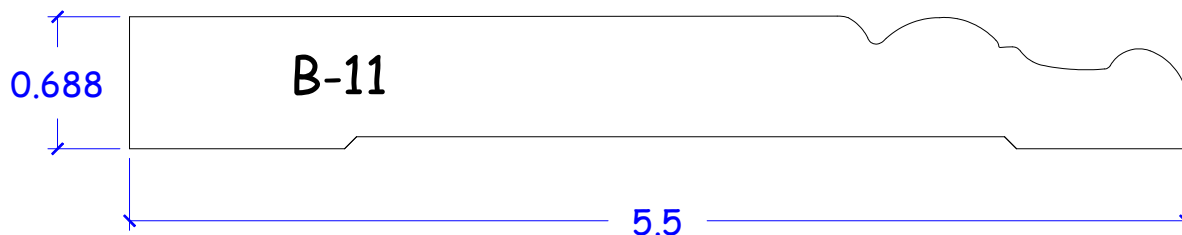
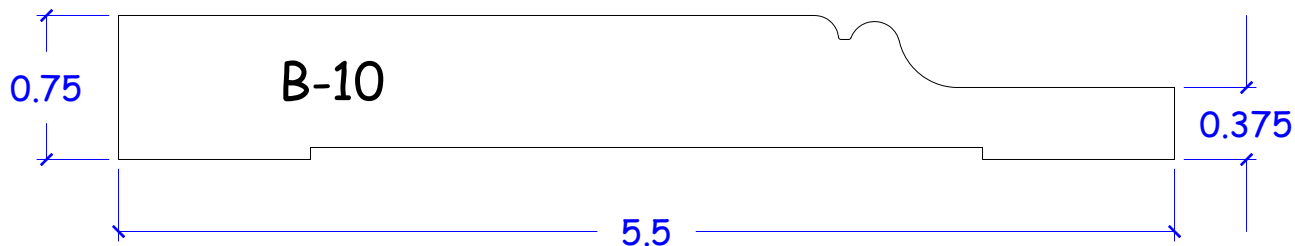
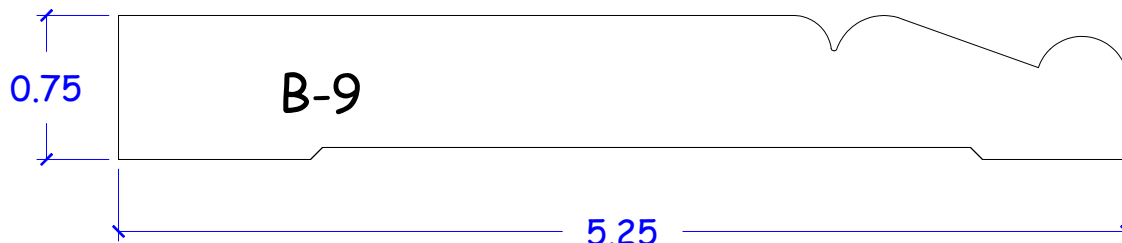
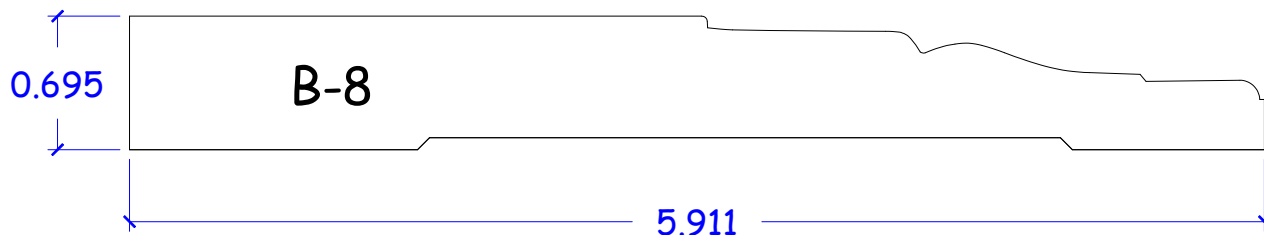
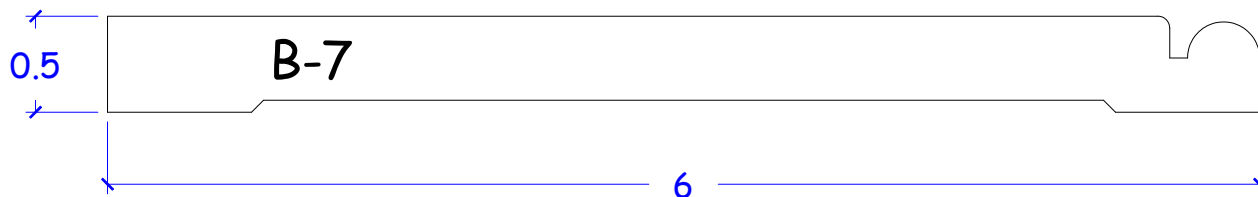

# Base Patterns

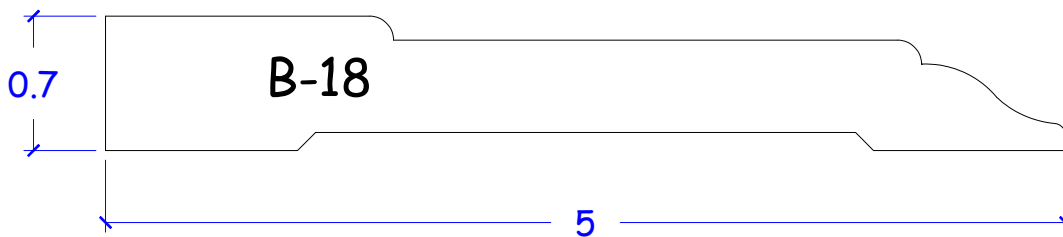
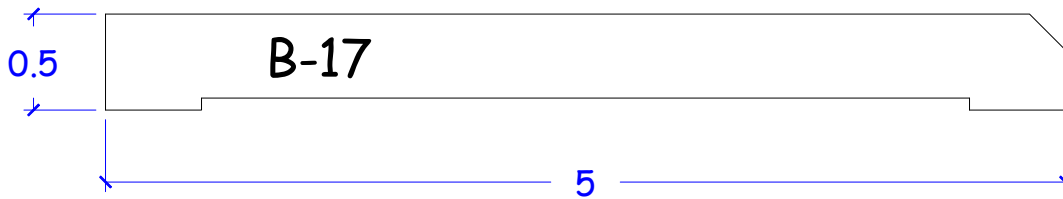
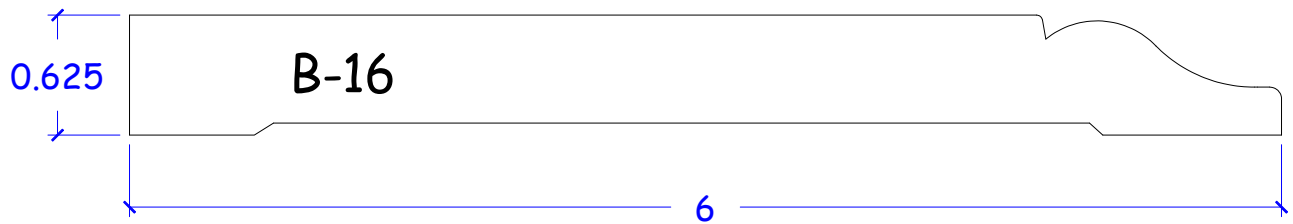
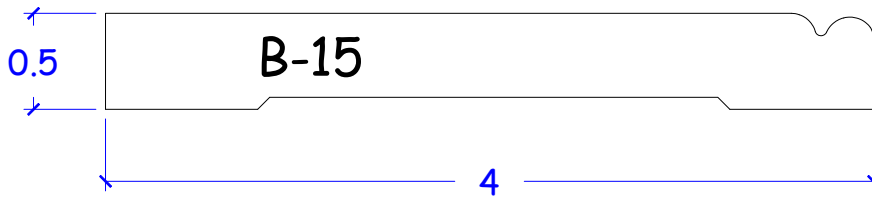
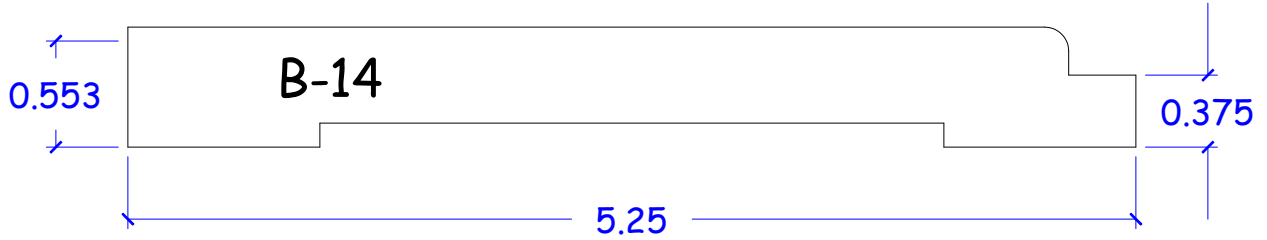
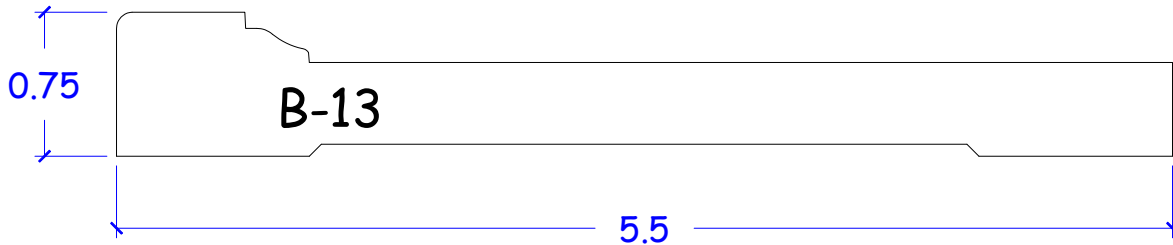

# Base Patterns

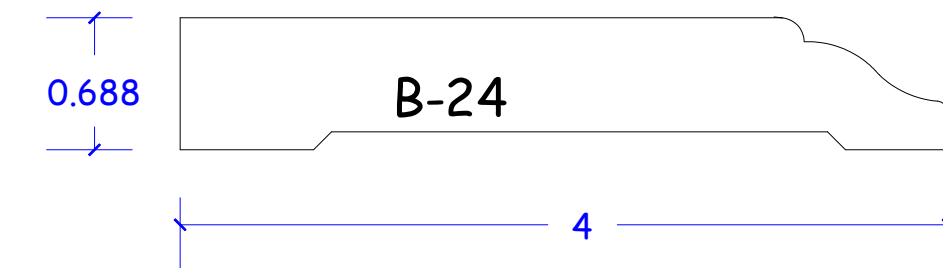
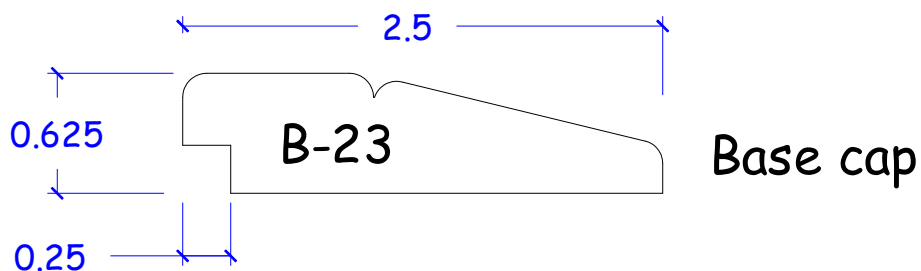
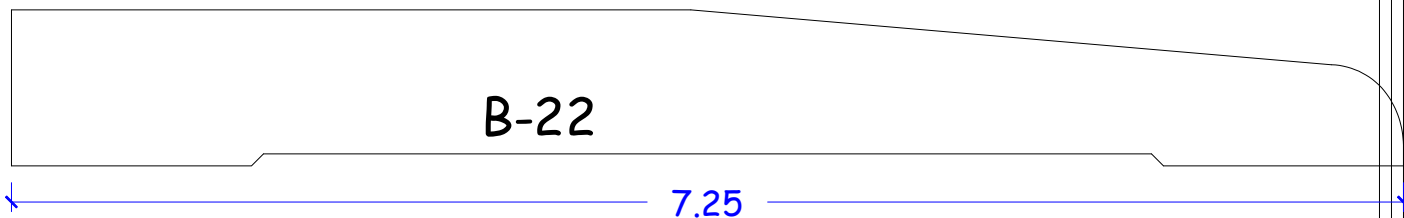
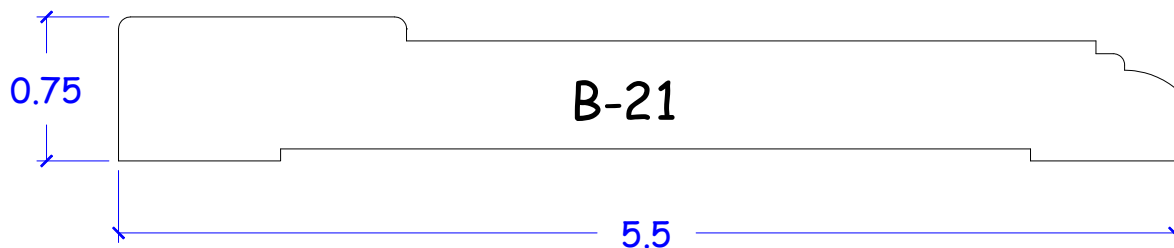
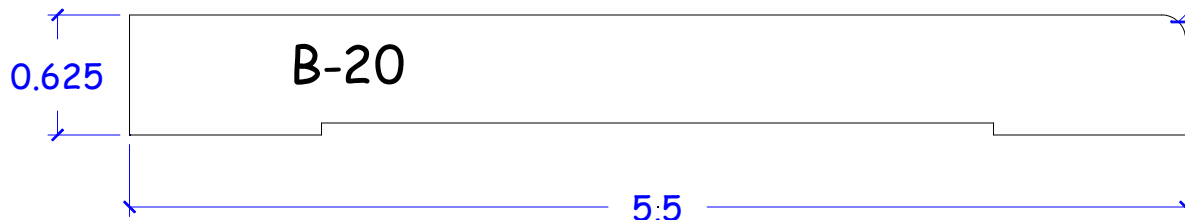
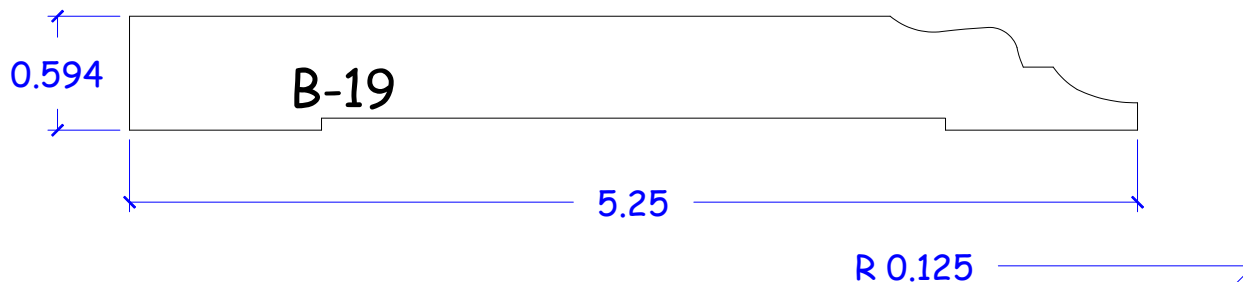

# Base Patterns

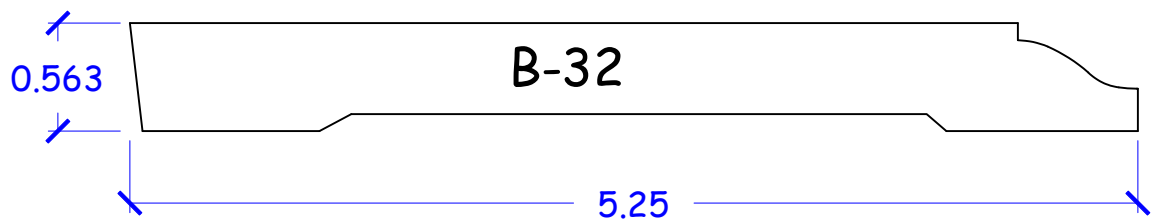
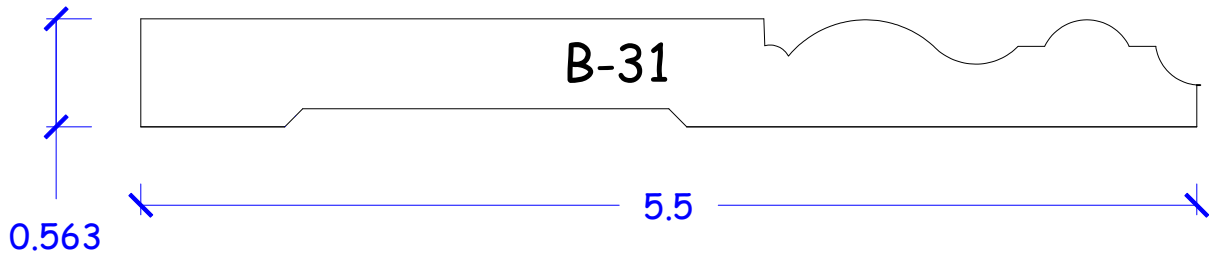
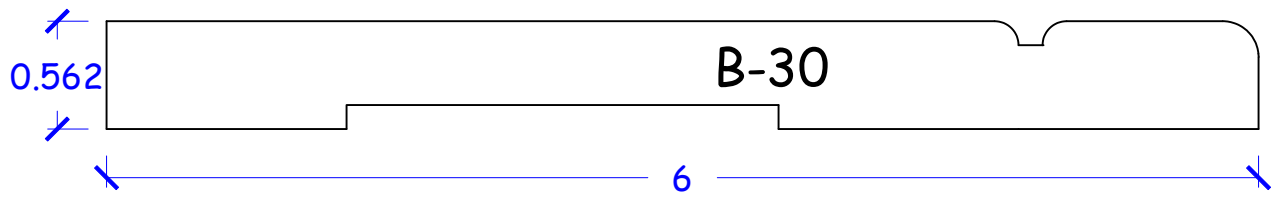
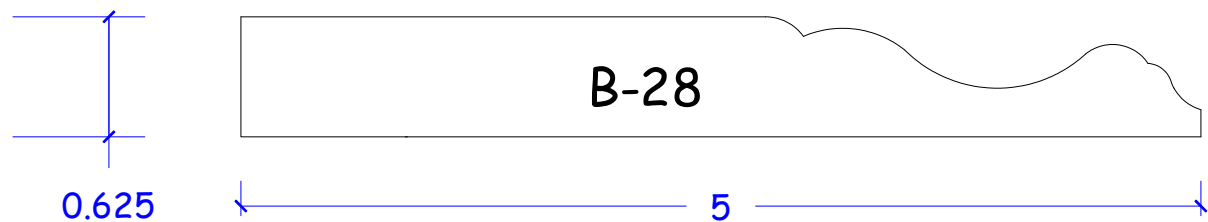
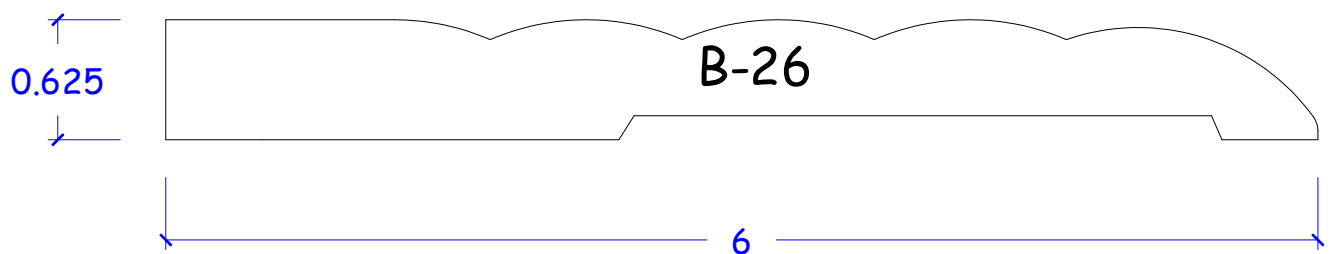
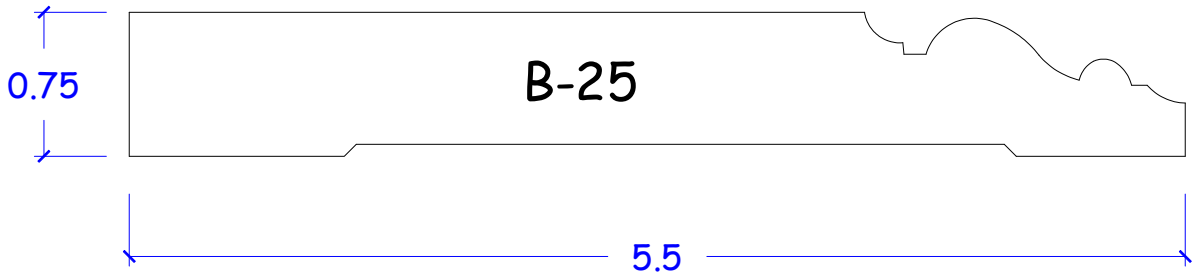

# Base Patterns

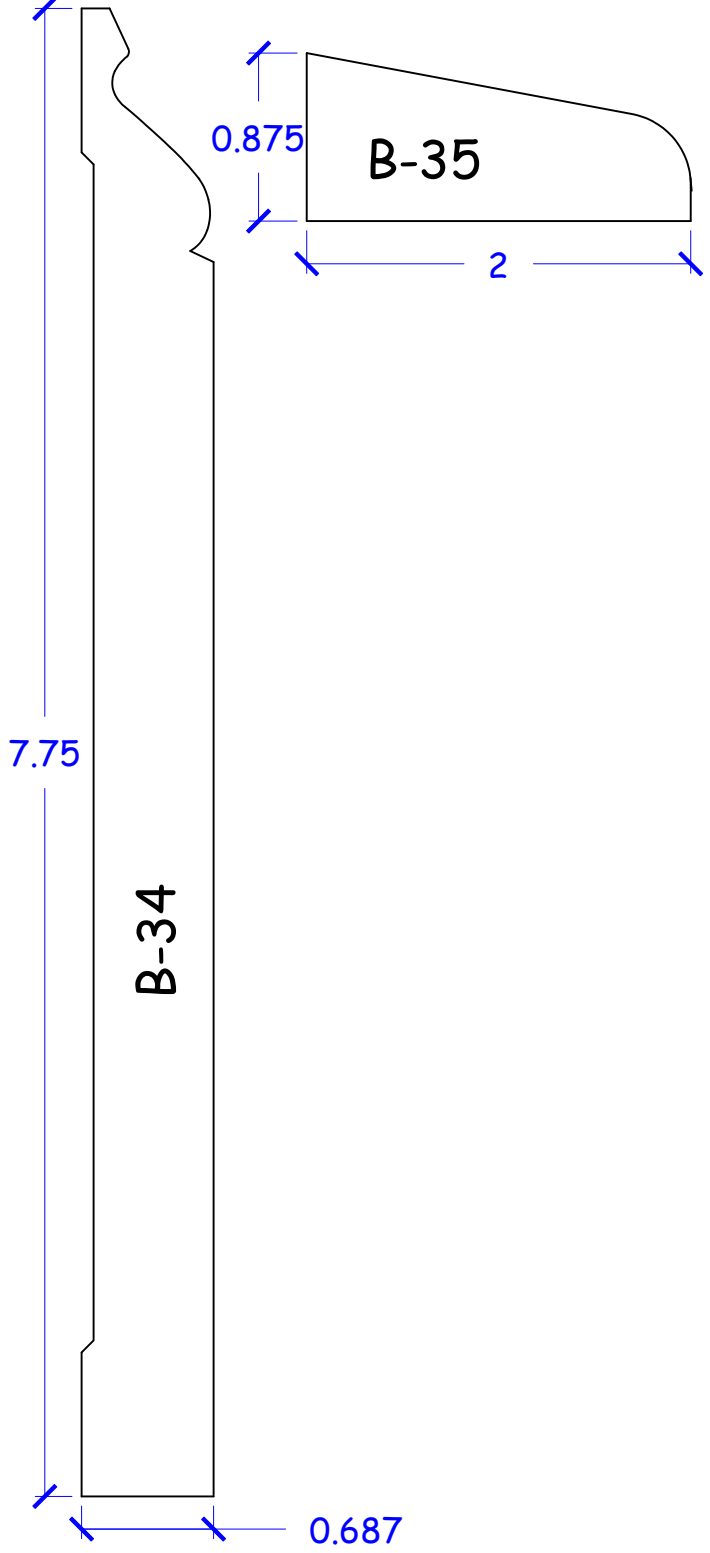
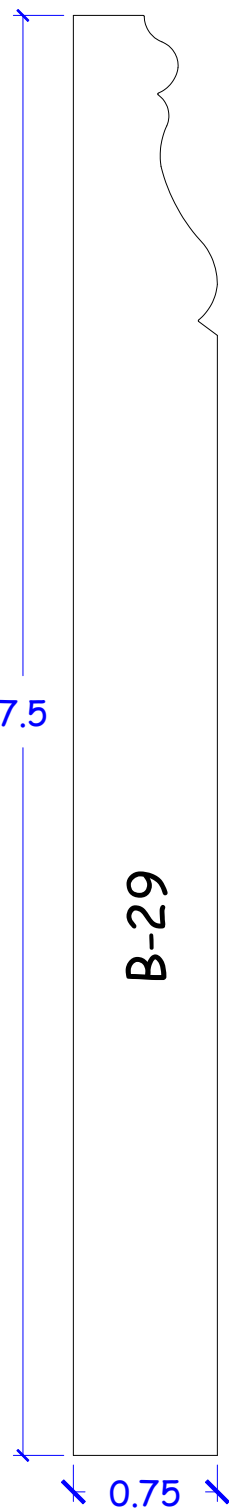
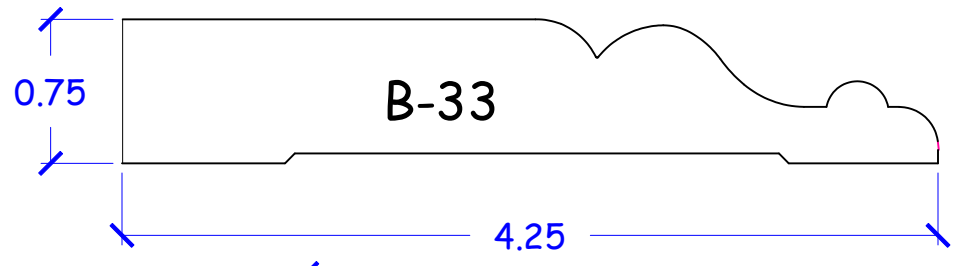
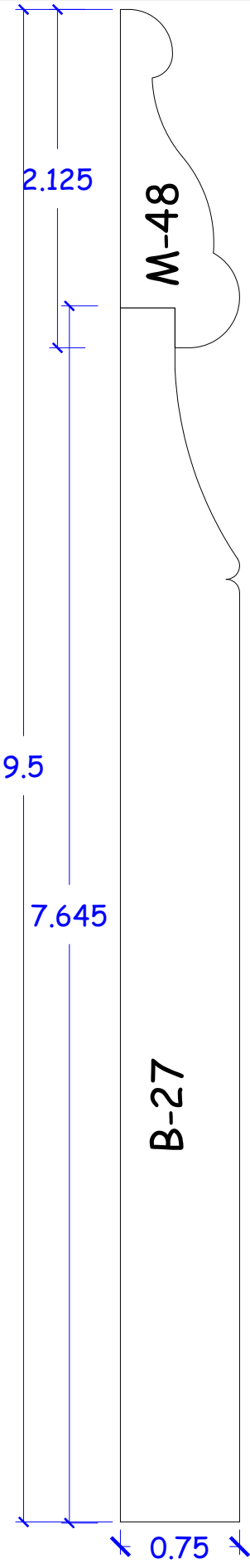

# Base Patterns

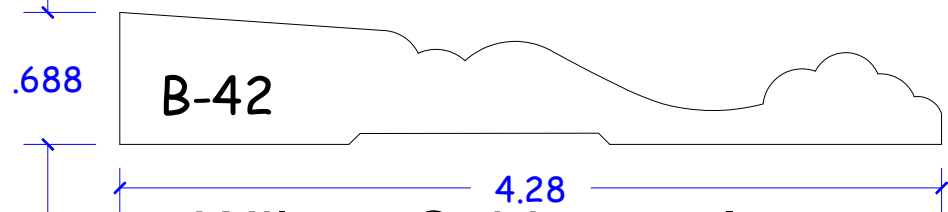
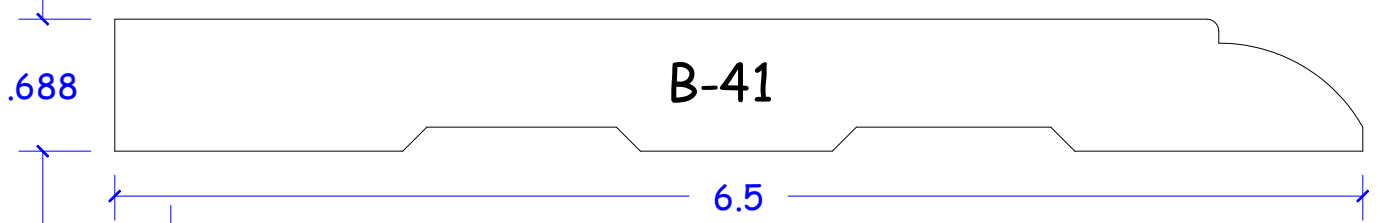
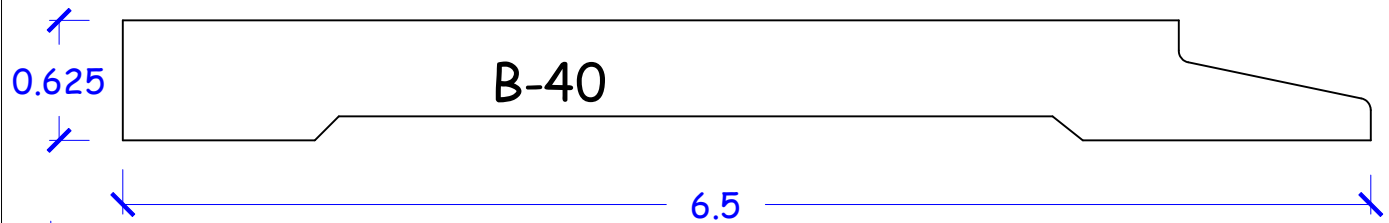
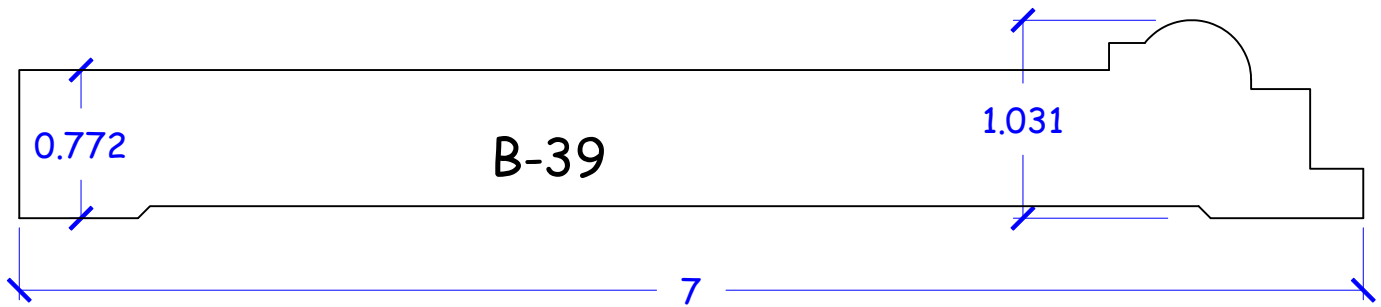
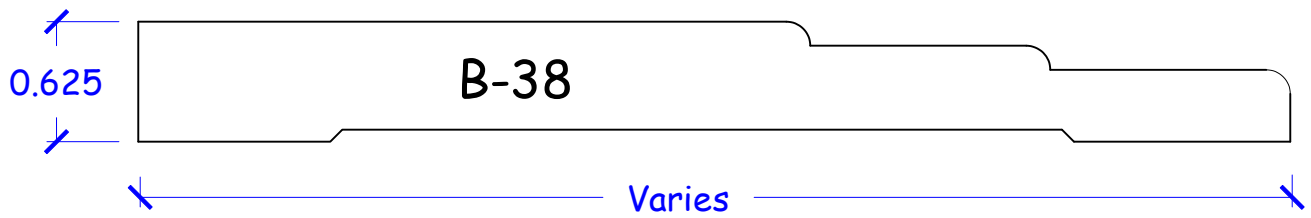
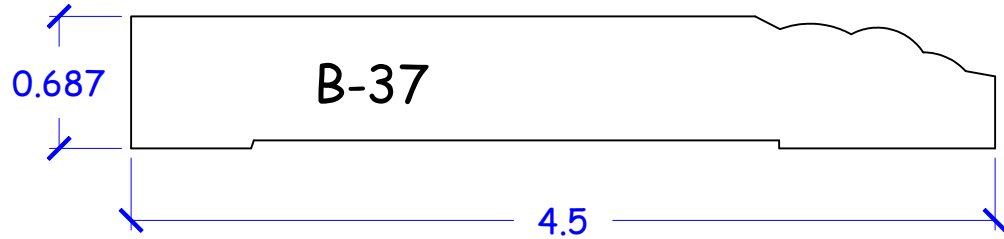
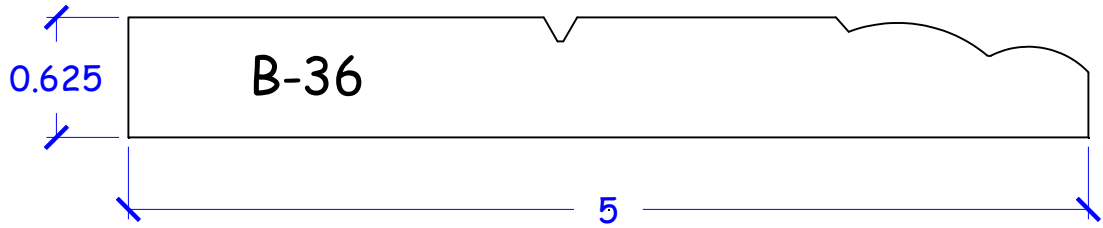



# Base Patterns

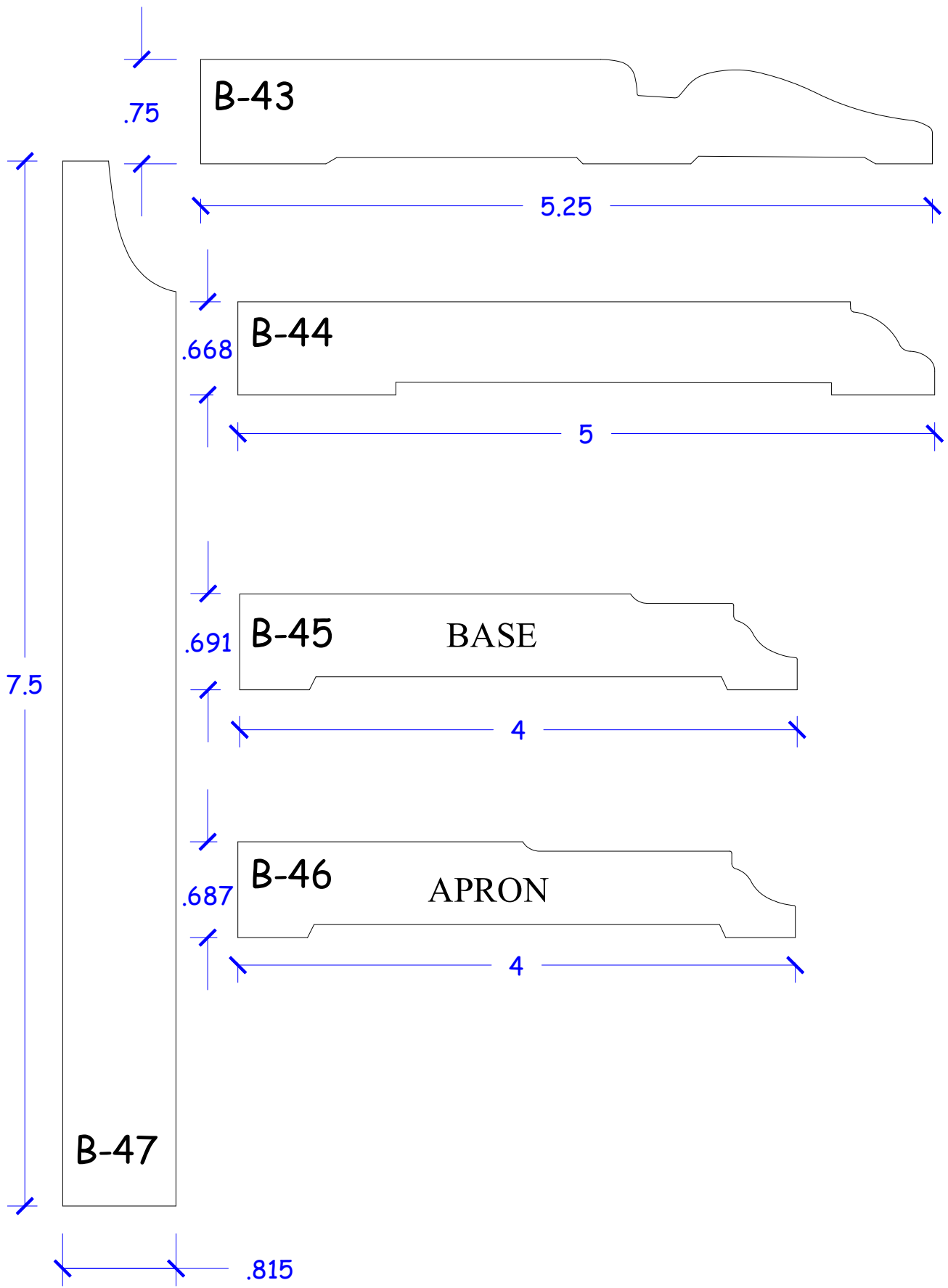

# Casing Patterns

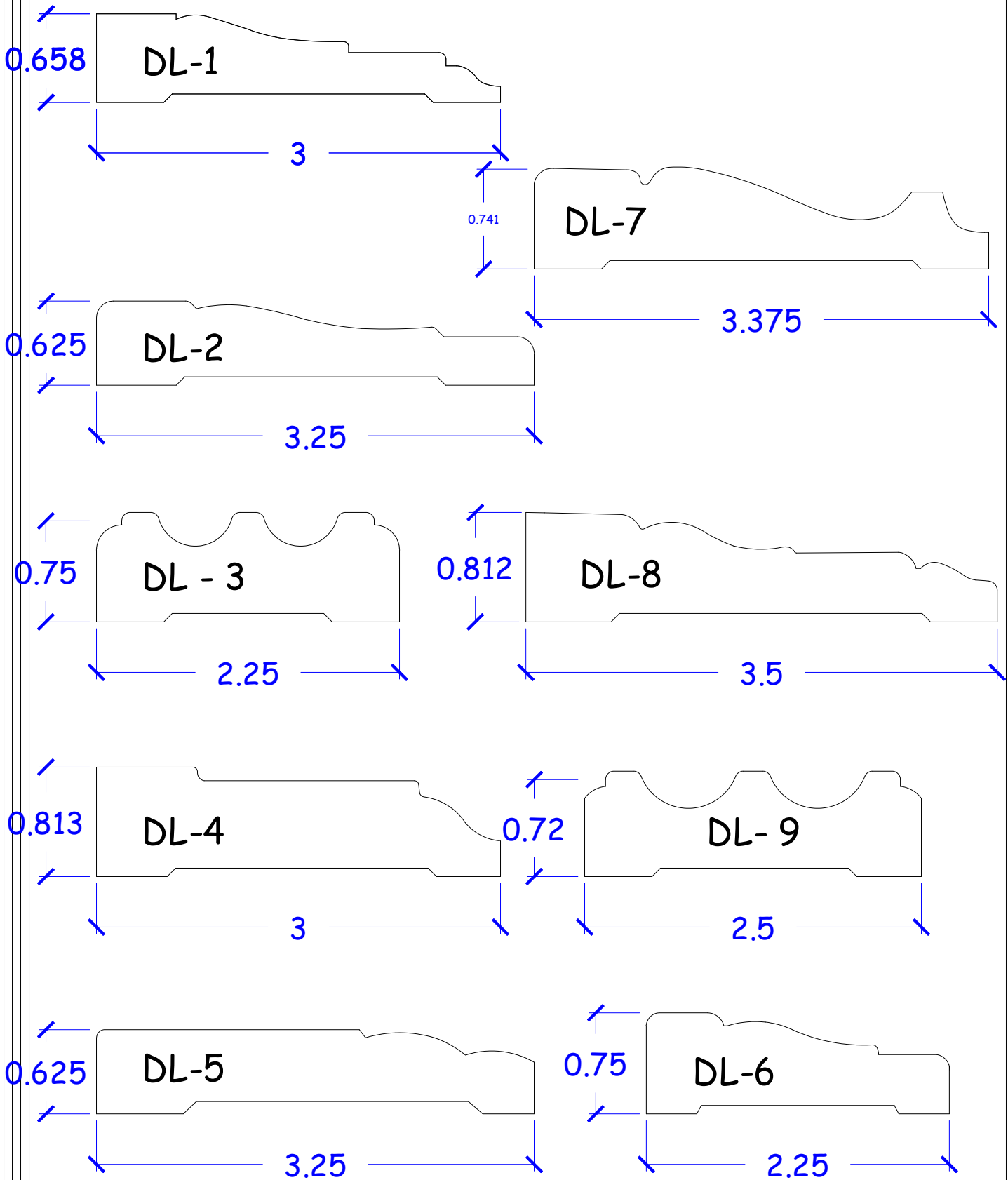

# Casing Patterns

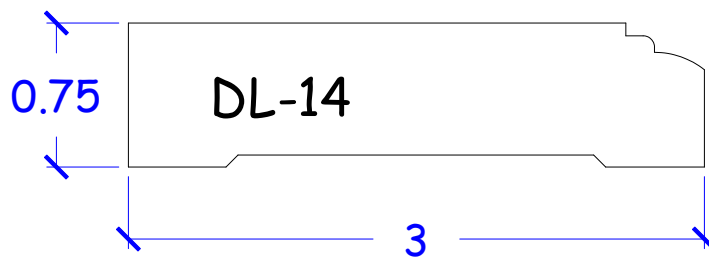
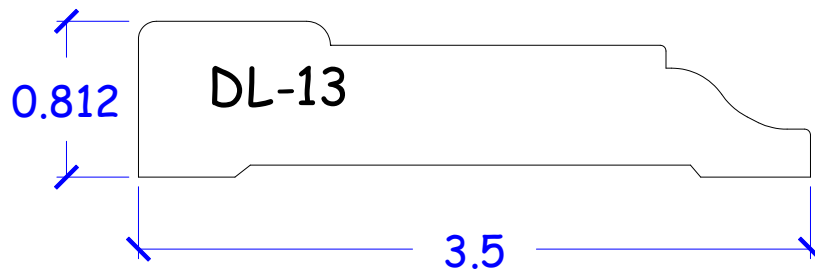
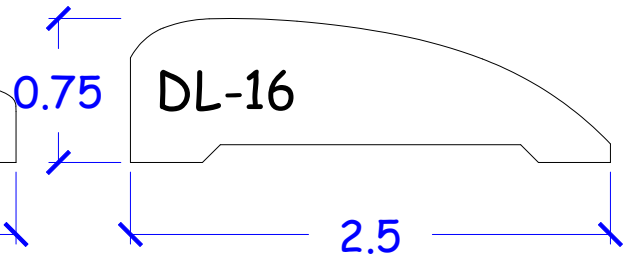
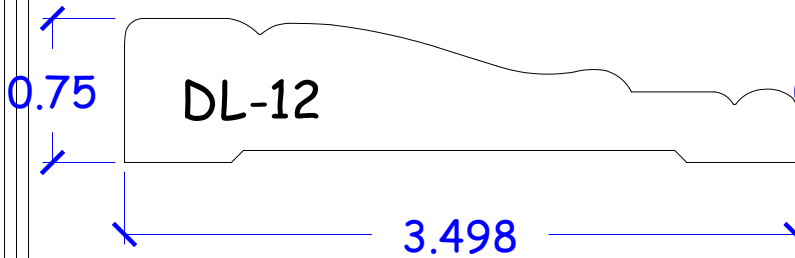
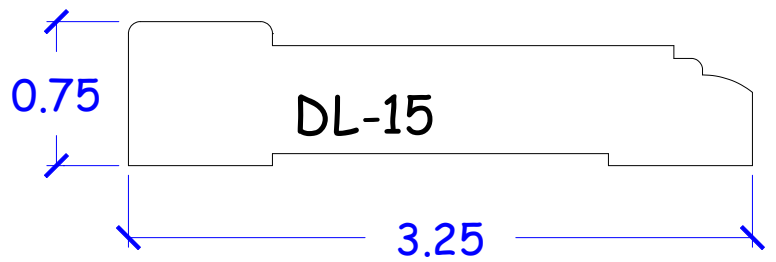
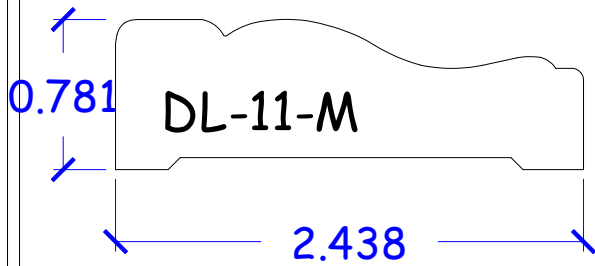
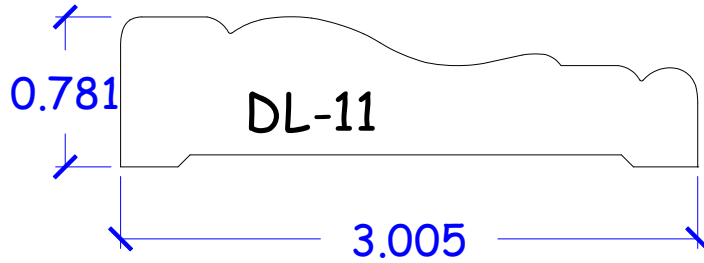
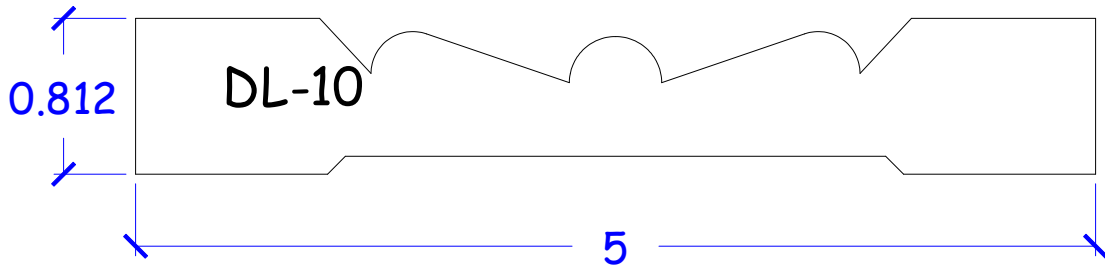

# Casing Patterns

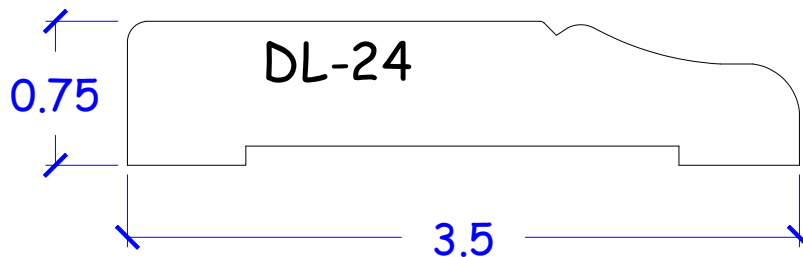
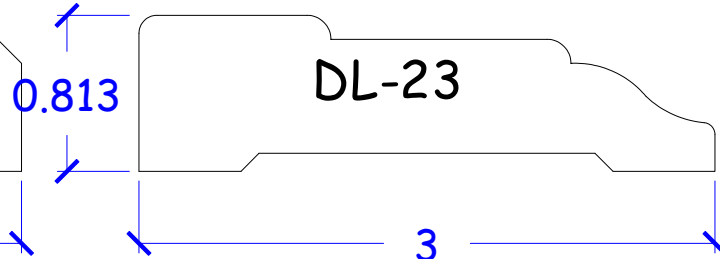
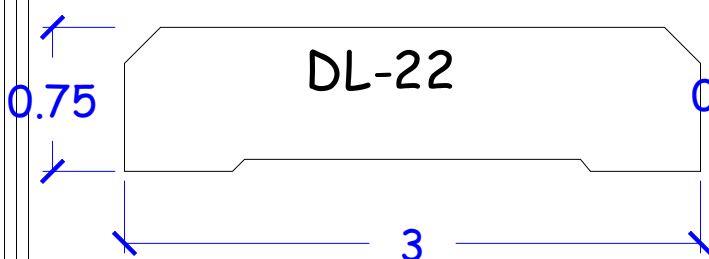
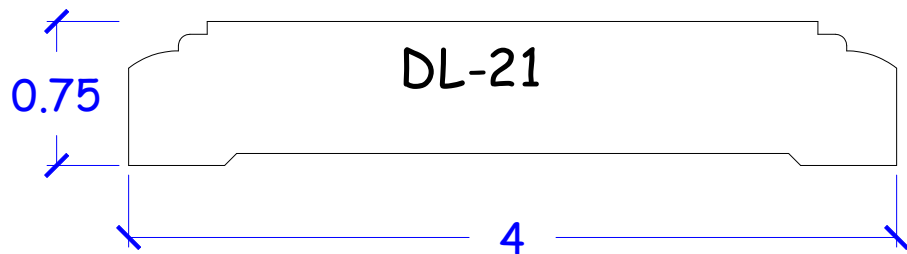
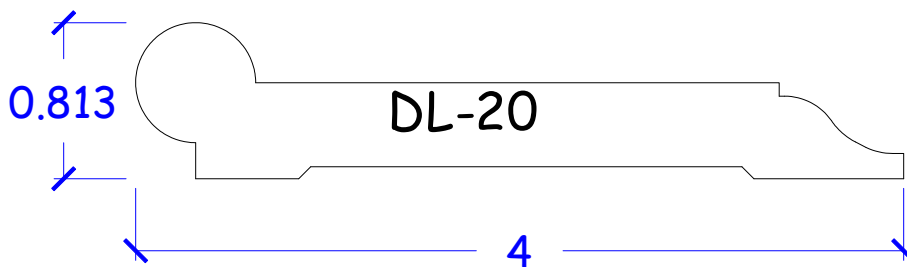
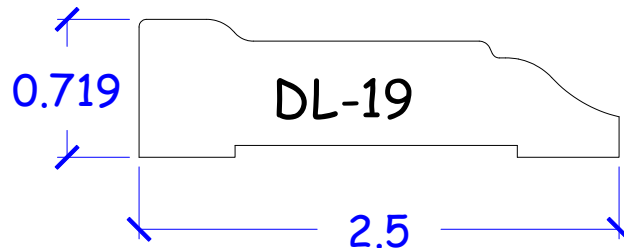
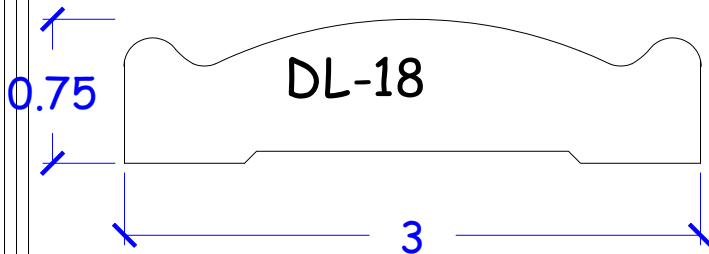
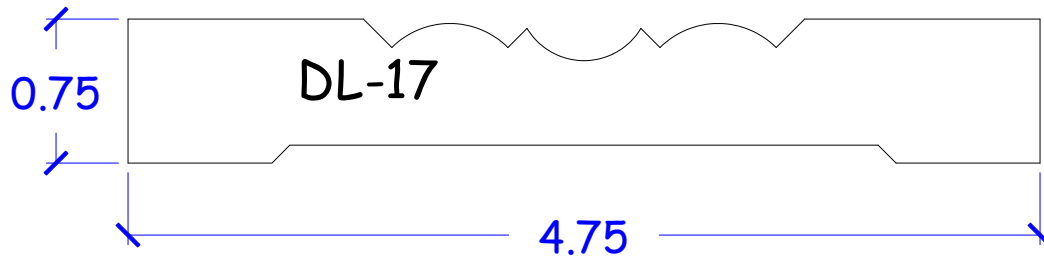

# Casing Patterns

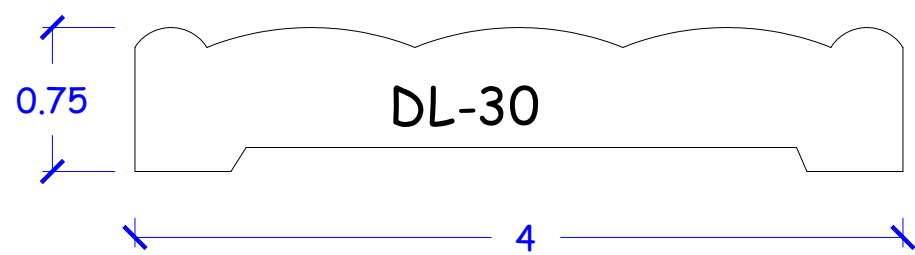
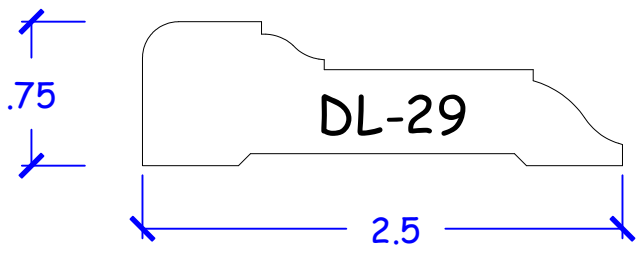
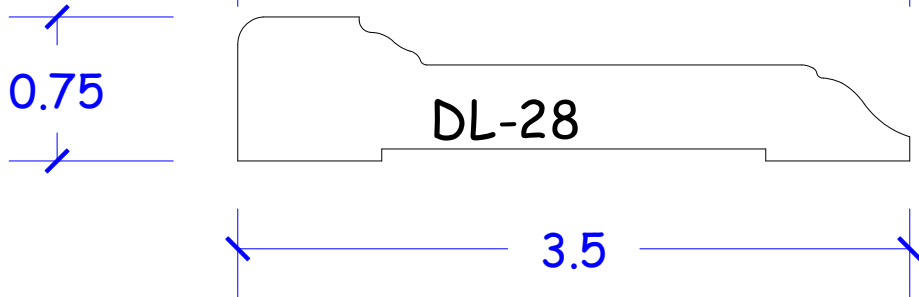
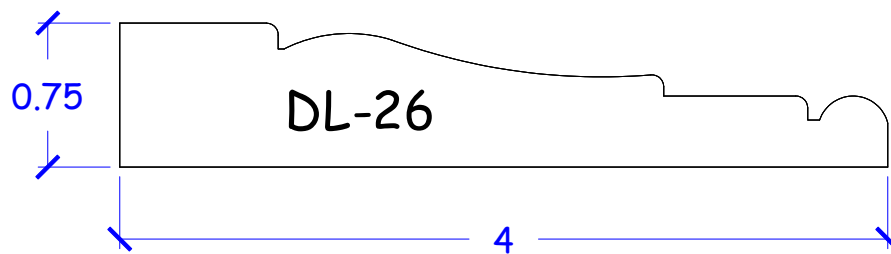
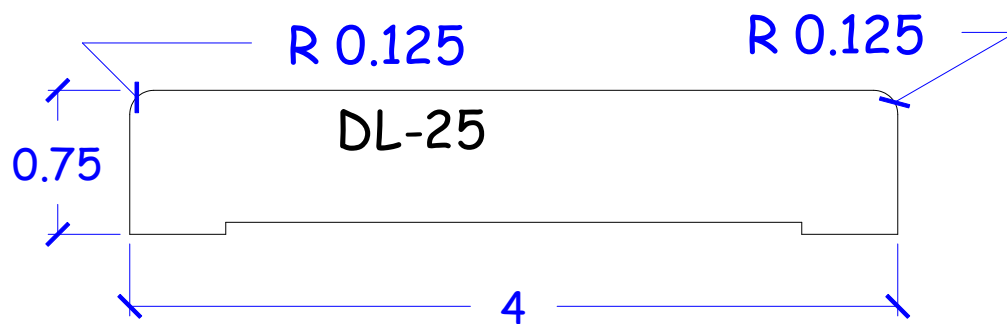

# Casing Patterns

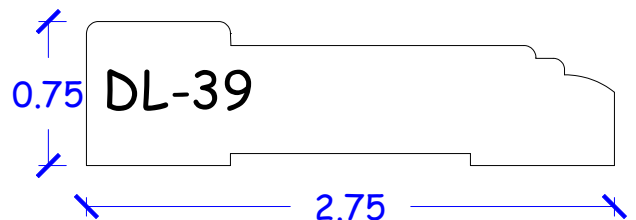
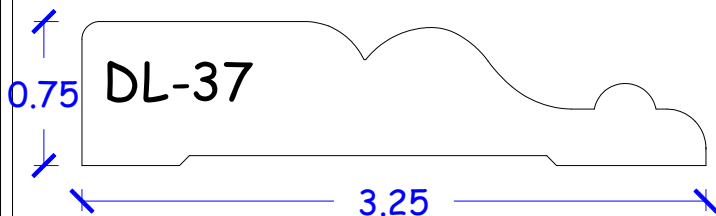
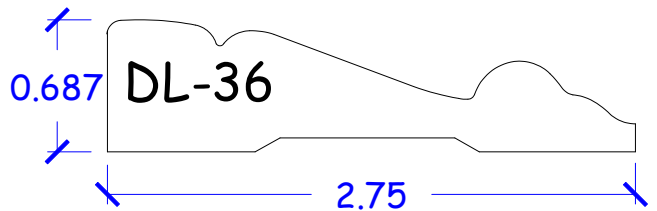
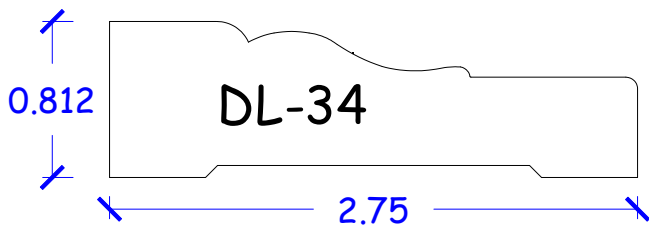
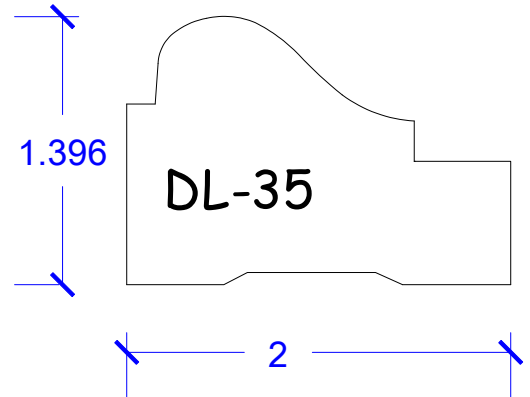
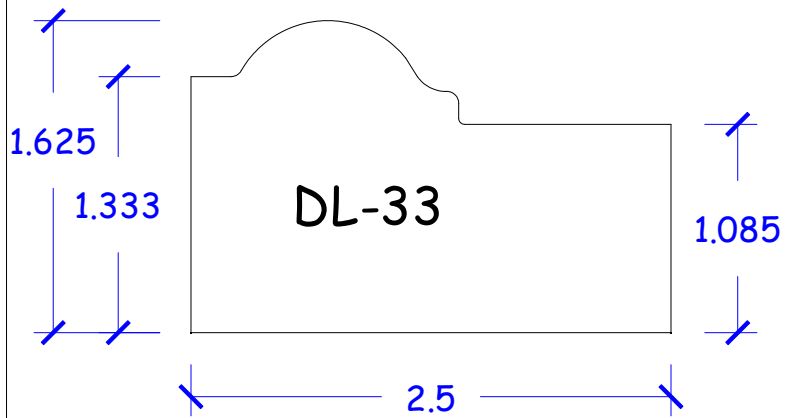
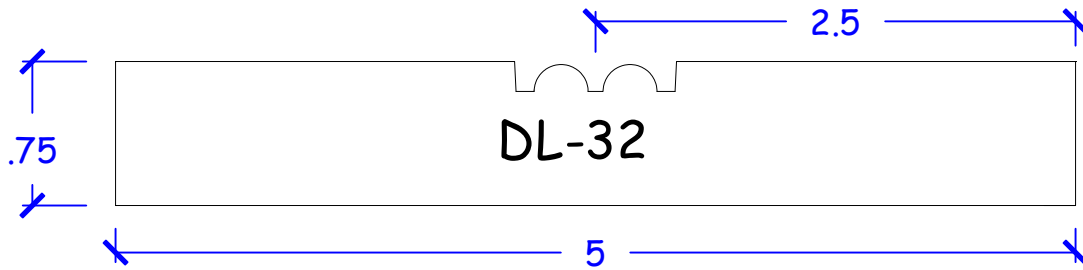
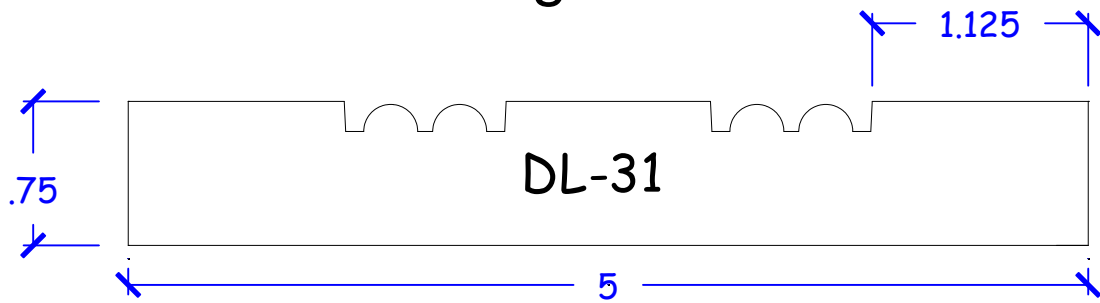

# Casing Patterns

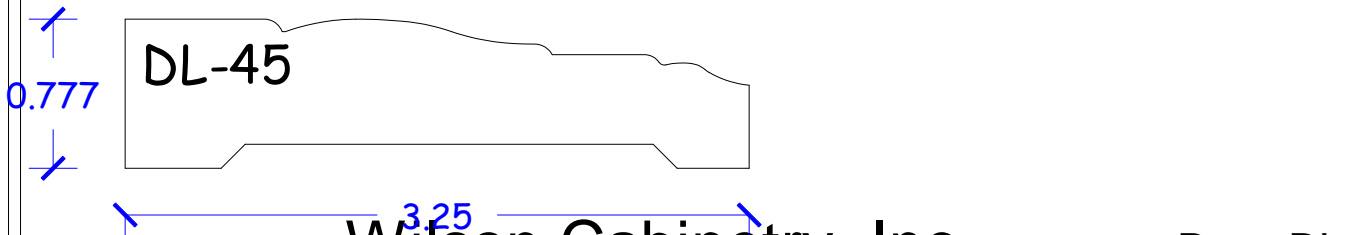
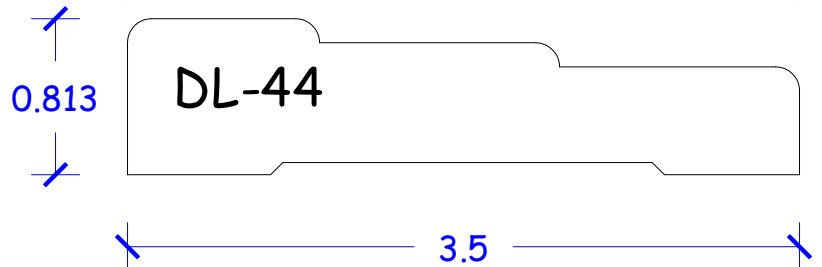
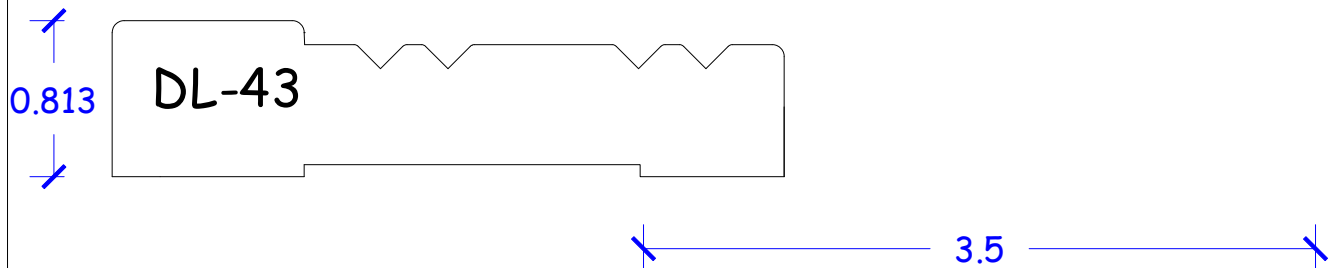
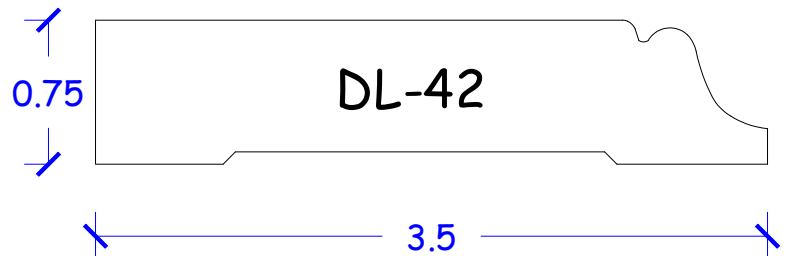
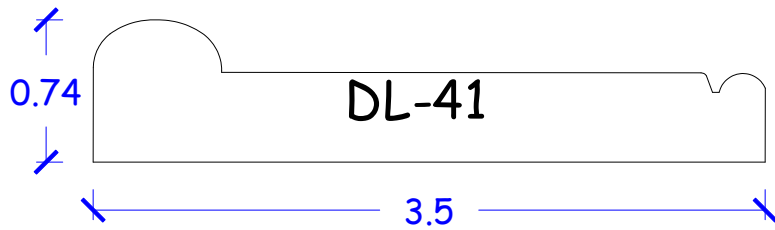
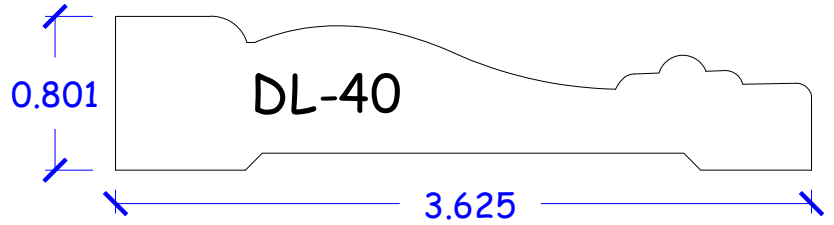
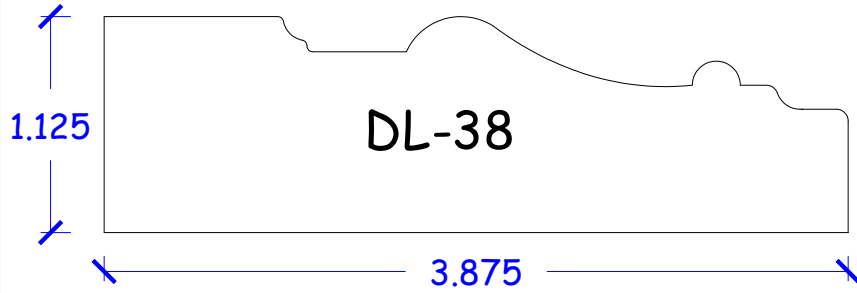

# Casing Patterns

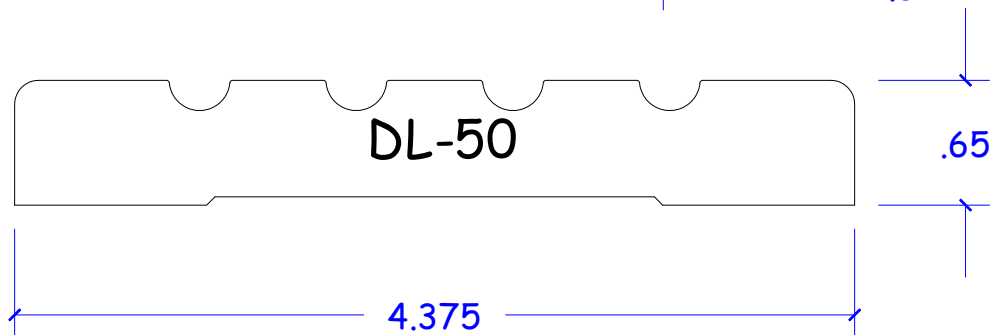
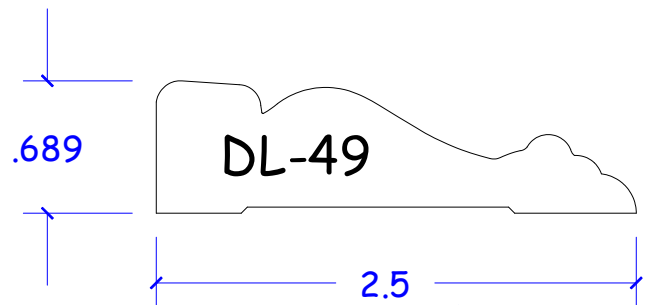
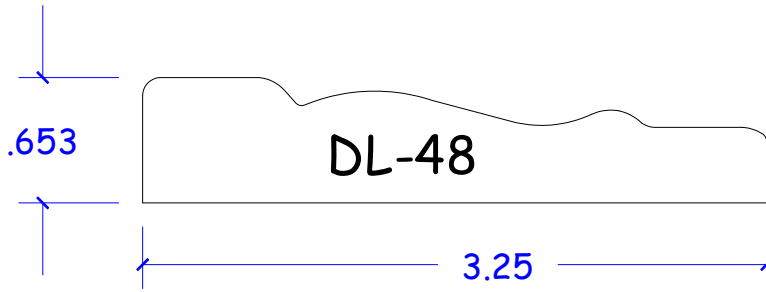
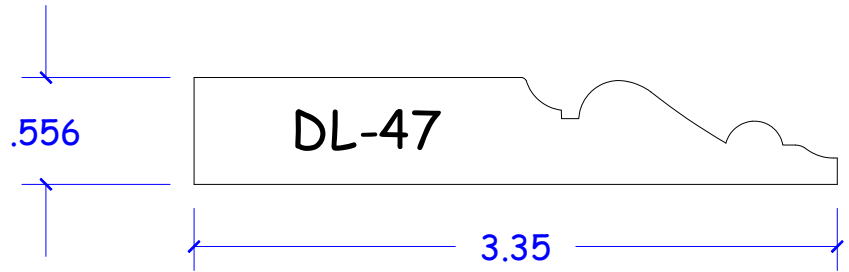
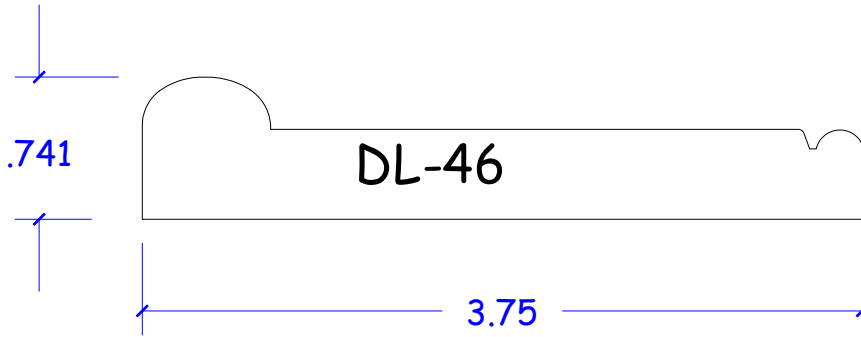



# Casing Patterns

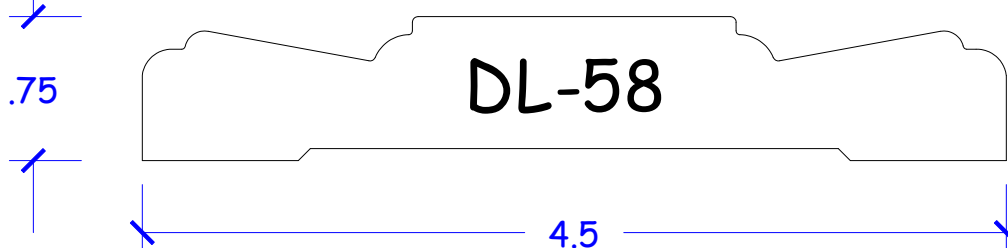
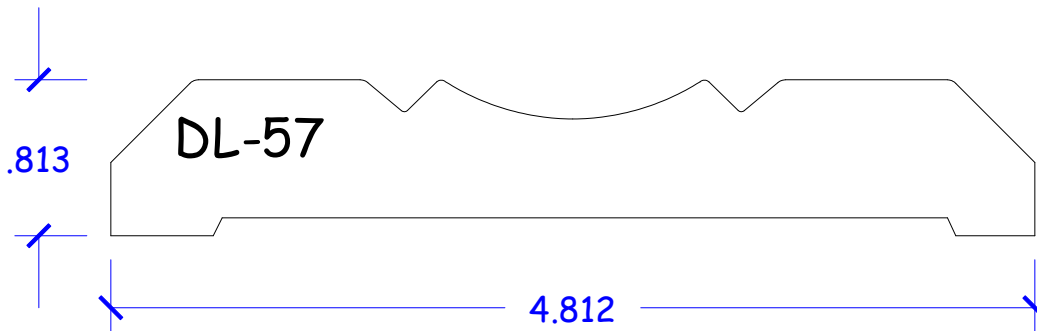
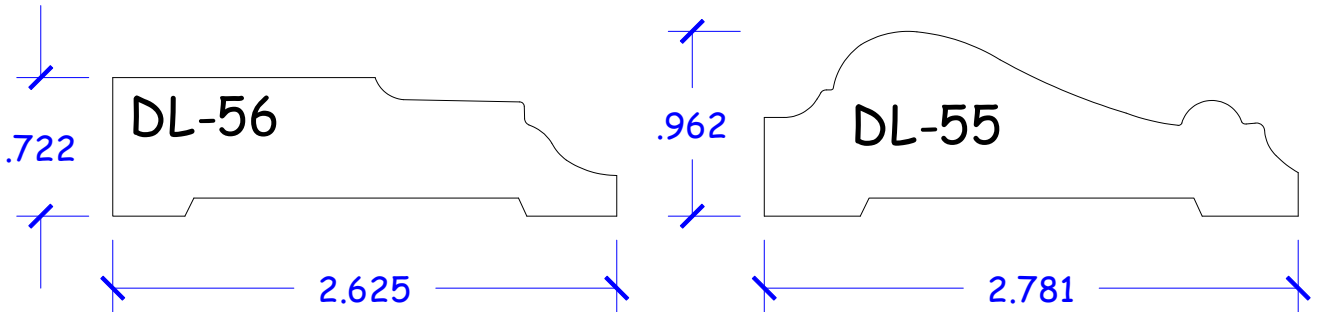
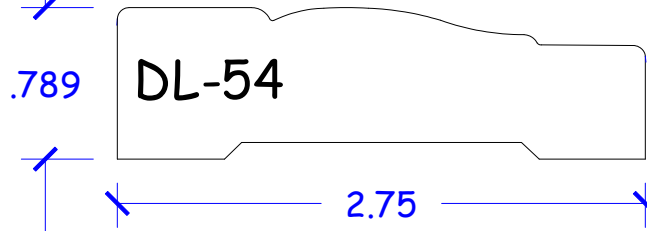
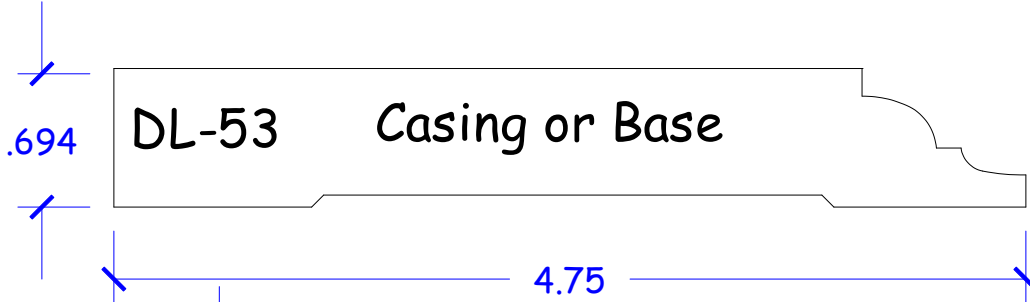
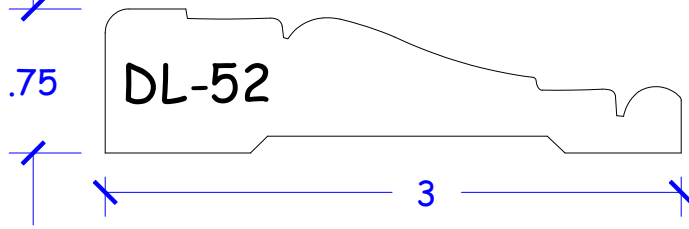

# Chair rail Patterns

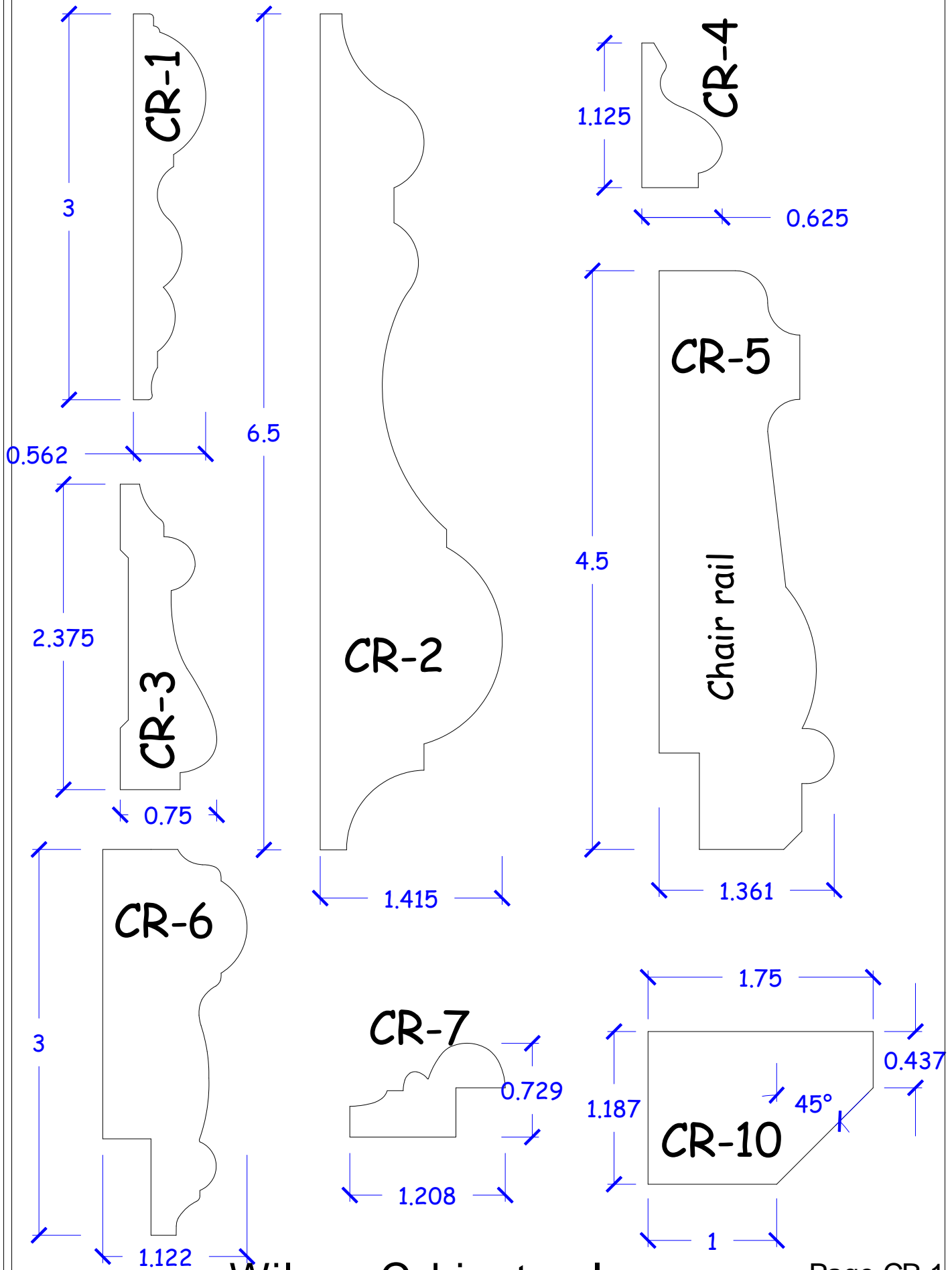

# Chair rail Patterns

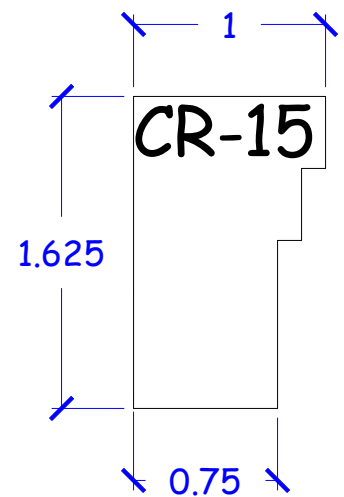
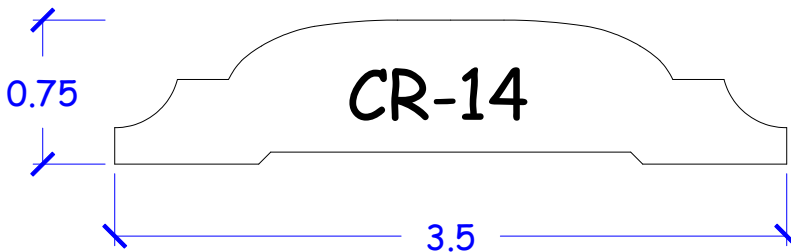
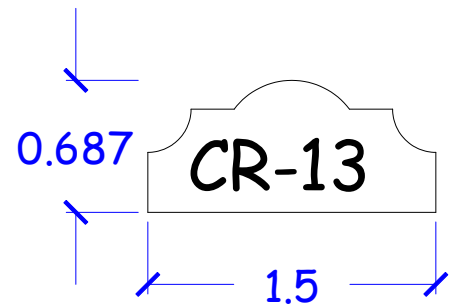
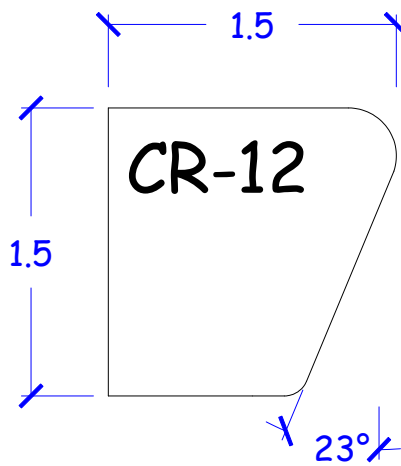
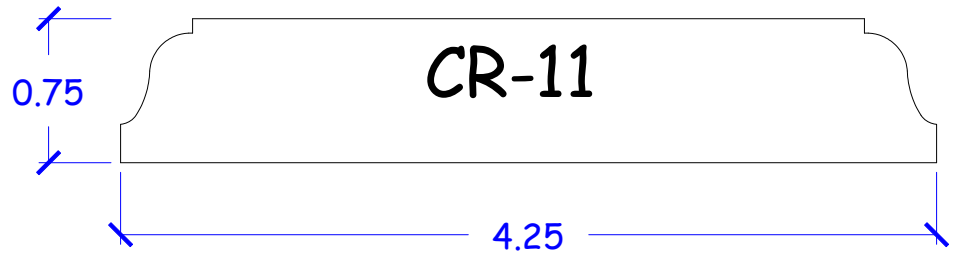
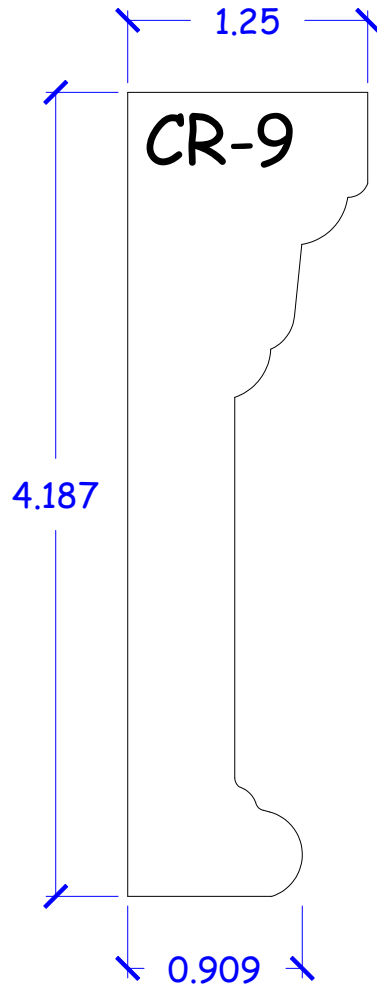
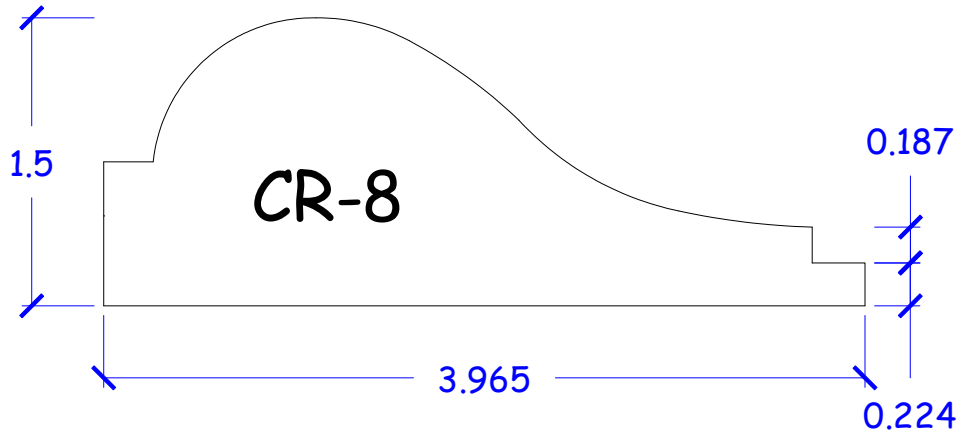

# Chair rail Patterns

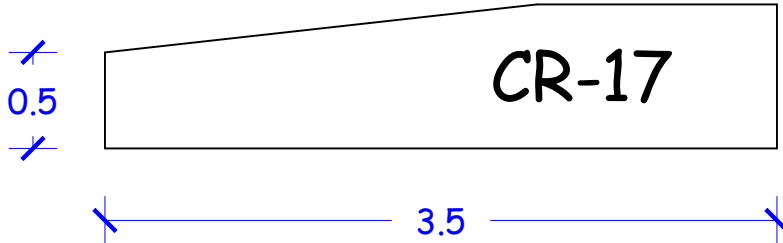
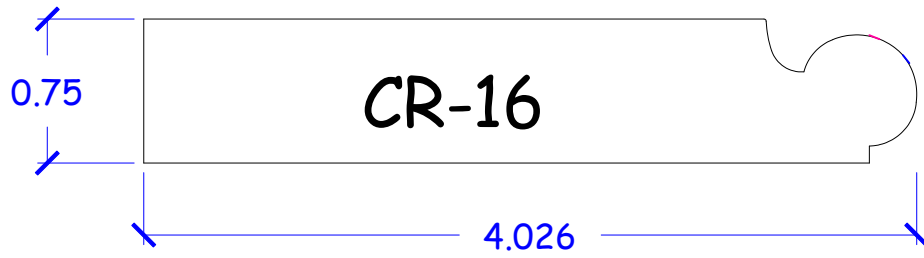

# CROWN Patterns

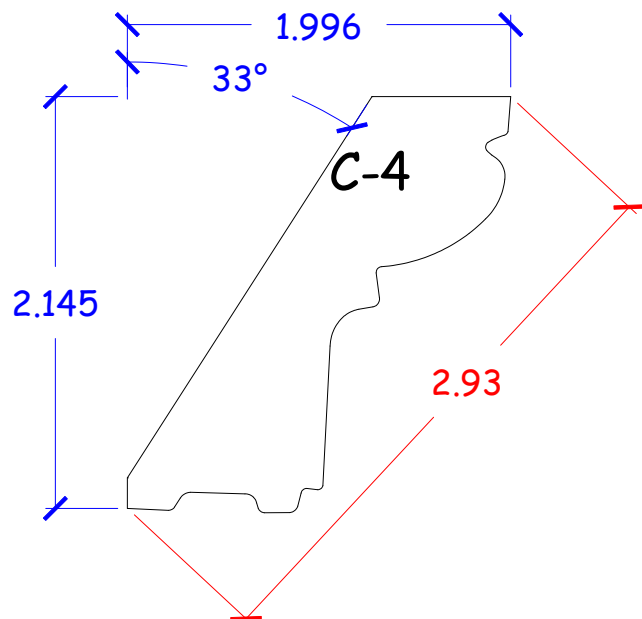
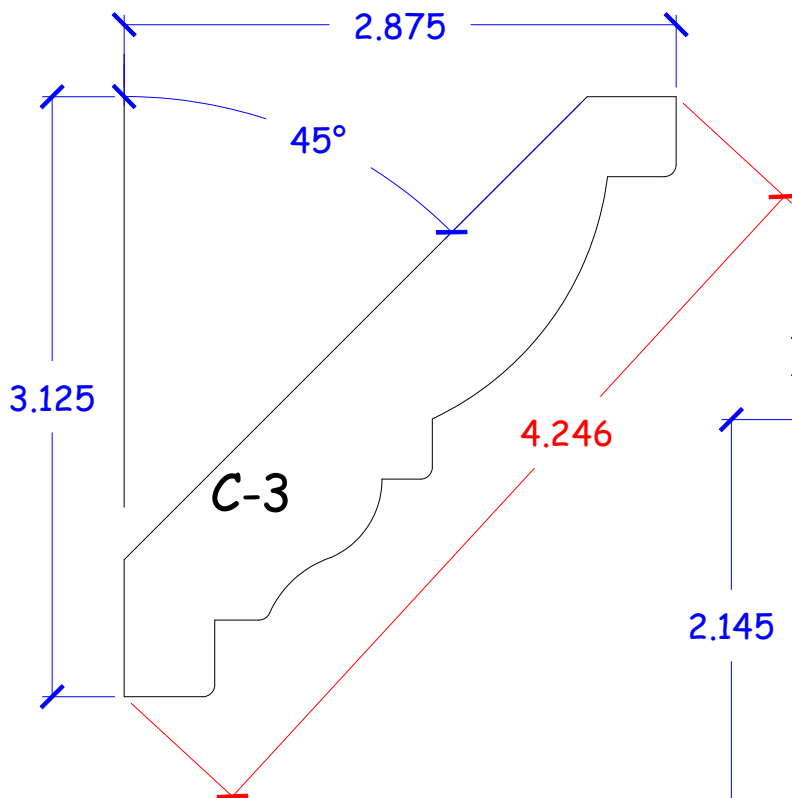
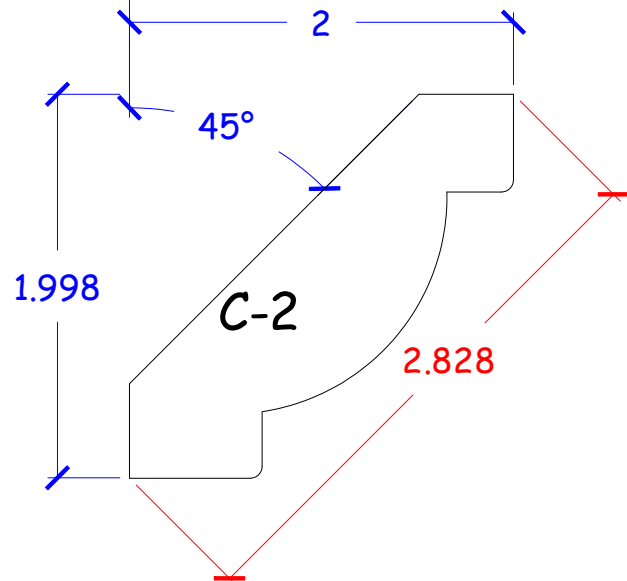
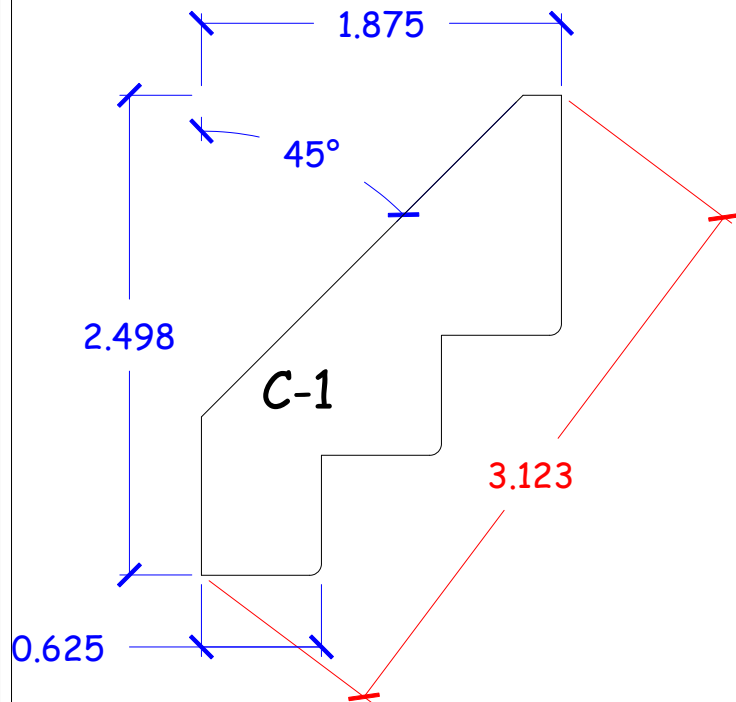

# CROWN Patterns

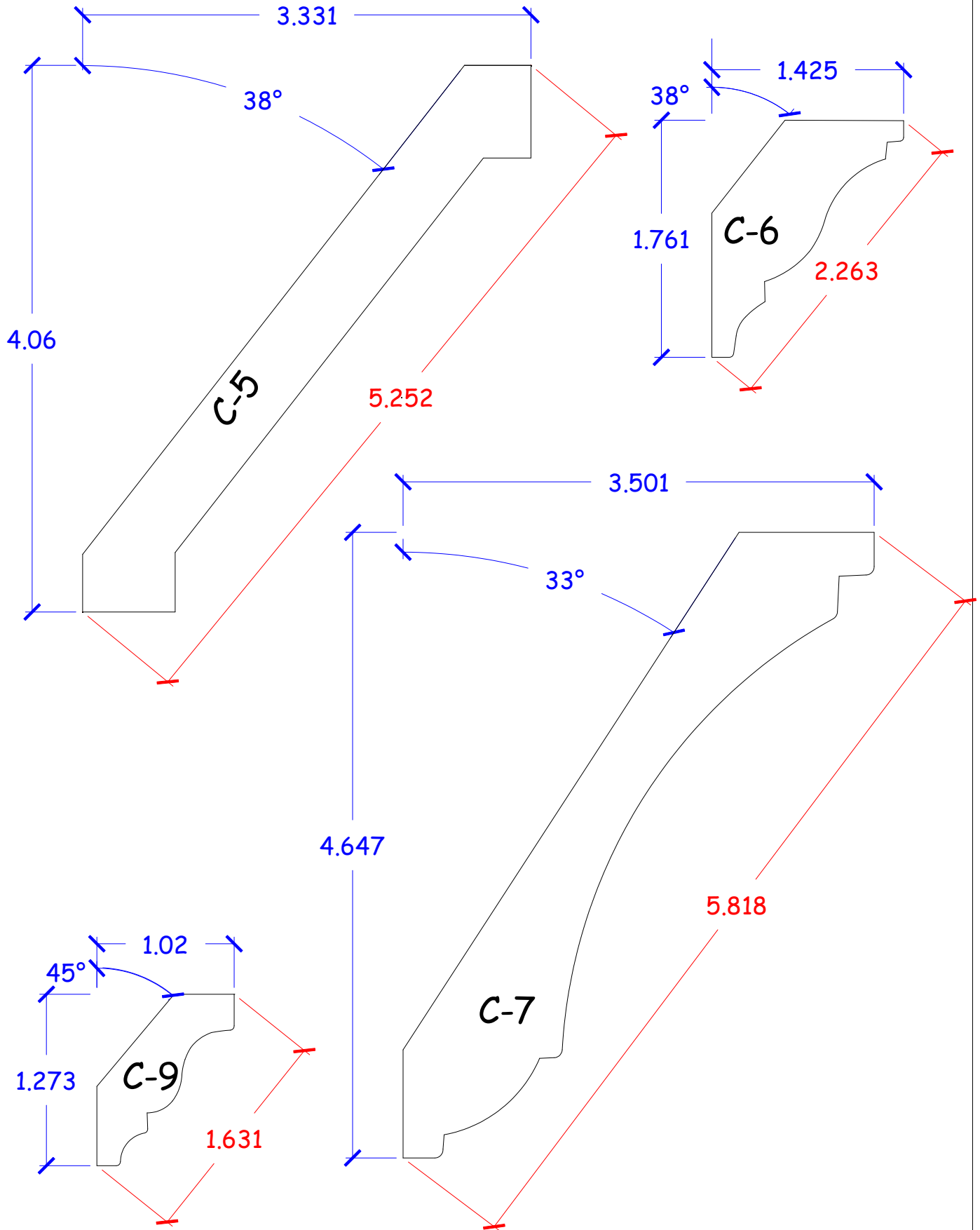

# CROWN Patterns

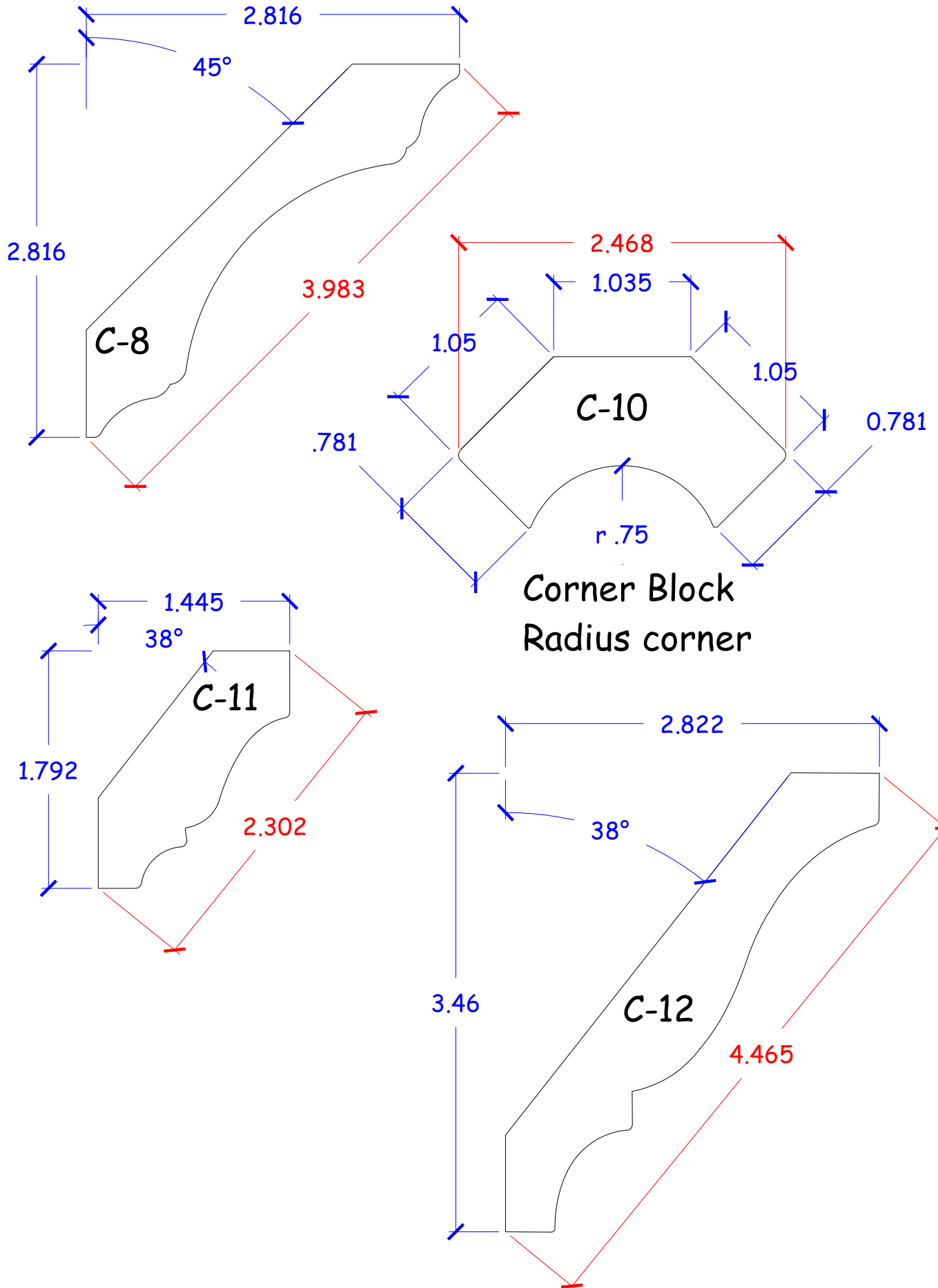

# CROWN Patterns

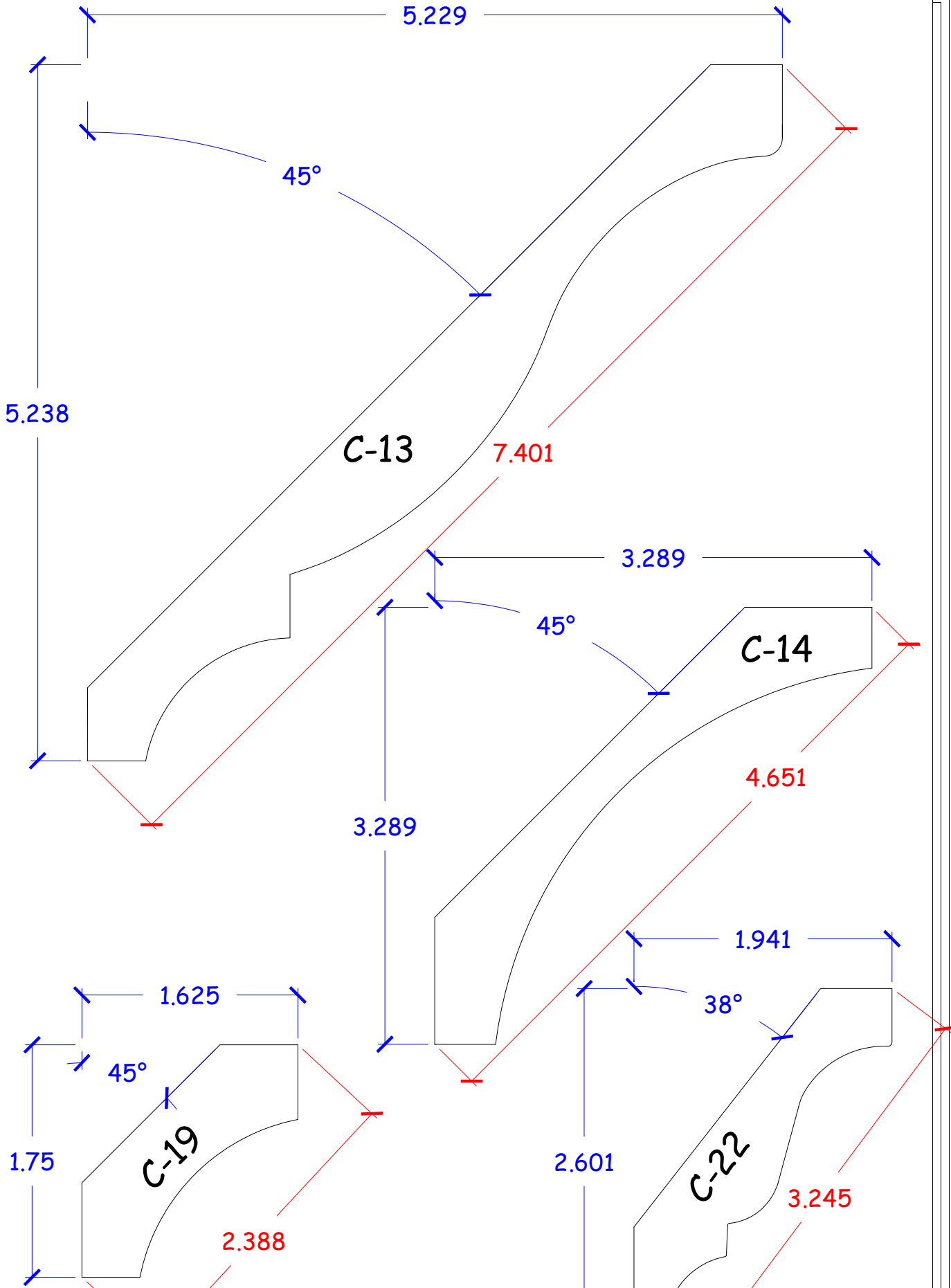

**Wilson Cabinetry, Inc.**

Page C-4



# CROWN Patterns

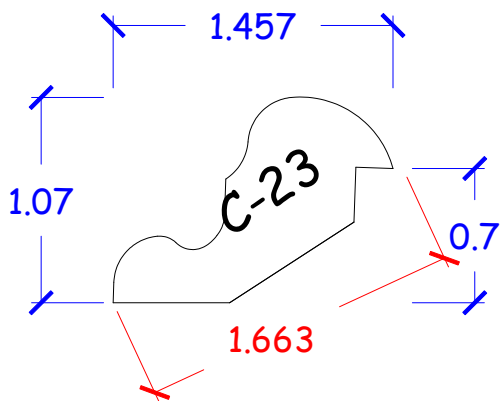
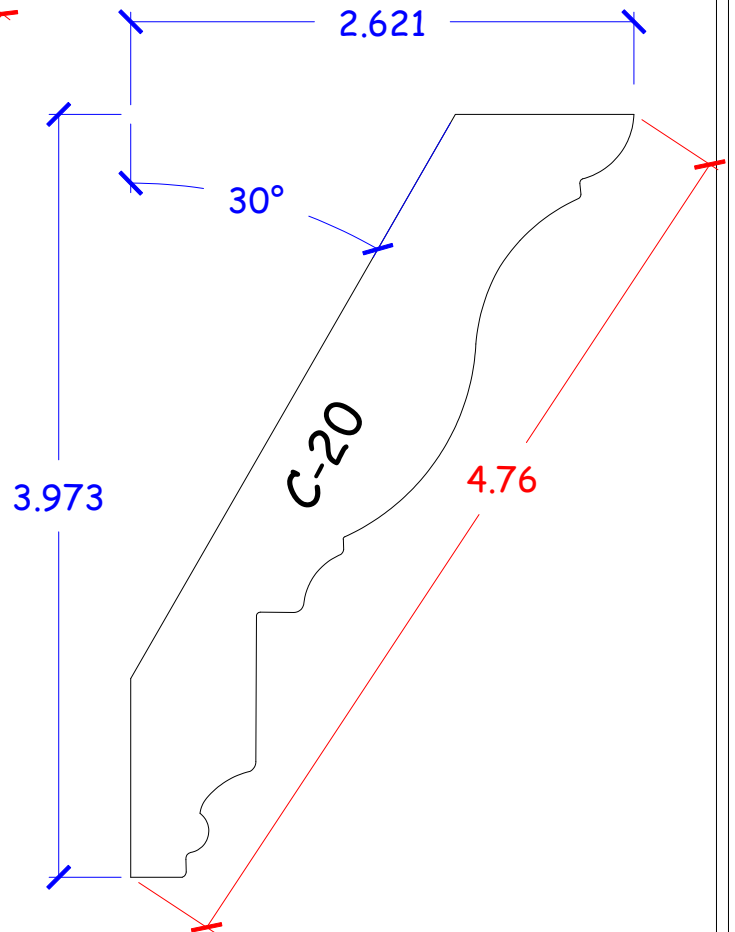
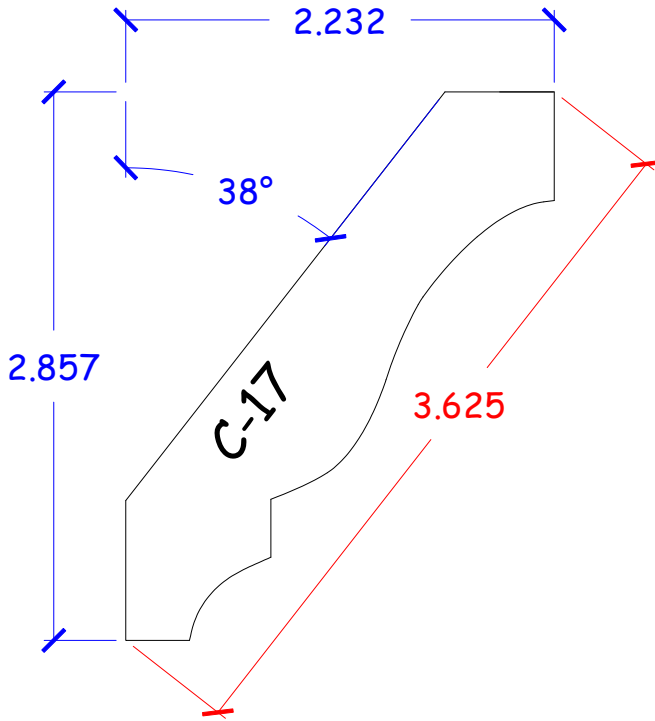
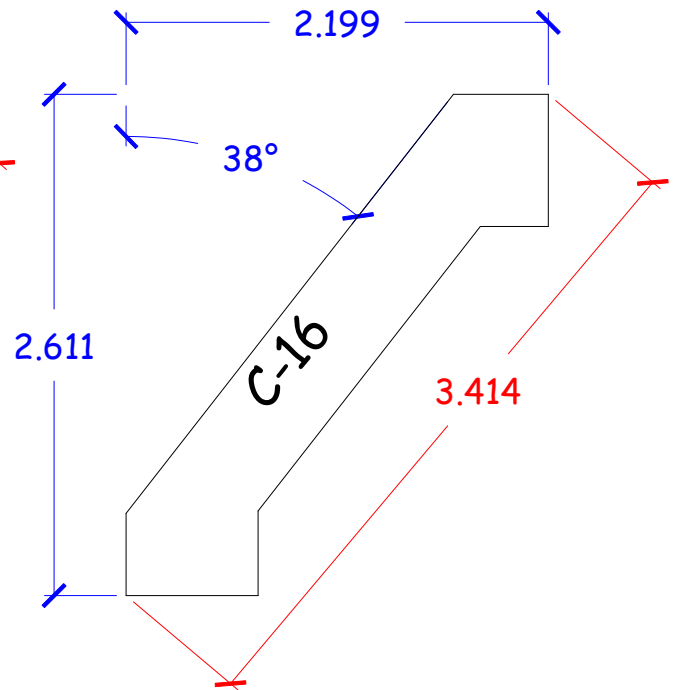
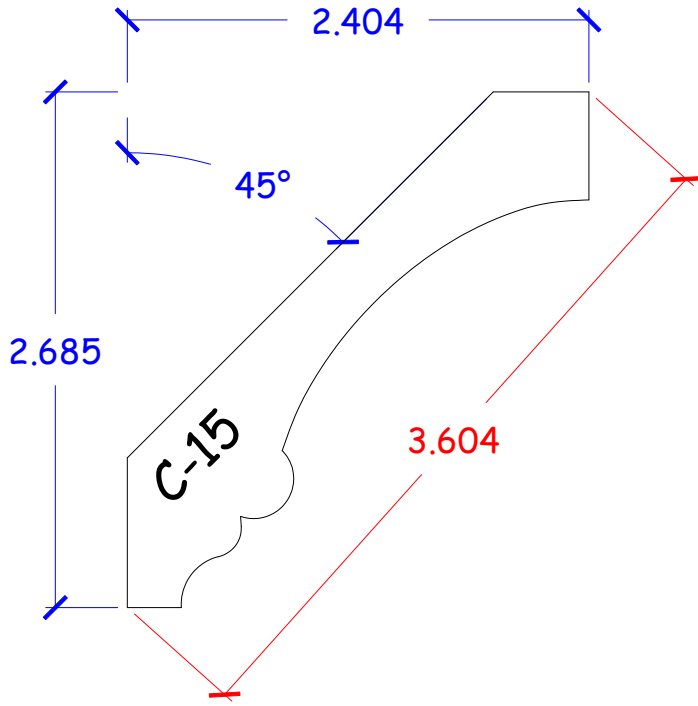

# CROWN Patterns

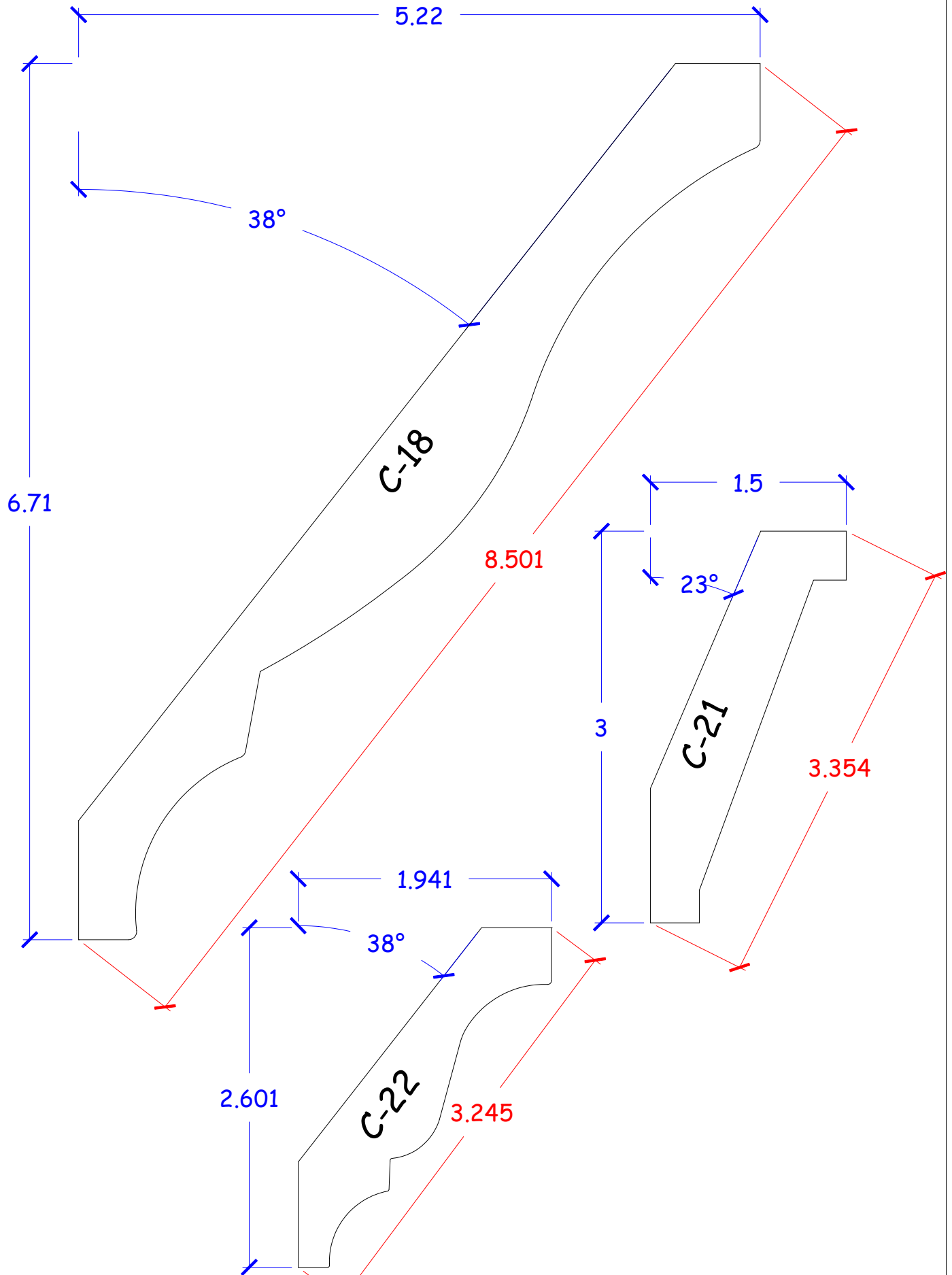

**Wilson Cabinetry, Inc.**

Page C-6

5046 Danford Dr  
Billings, MT 59106

(406) 652-4671 Phone  
(406) 652-1260 Fax

# CROWN Patterns

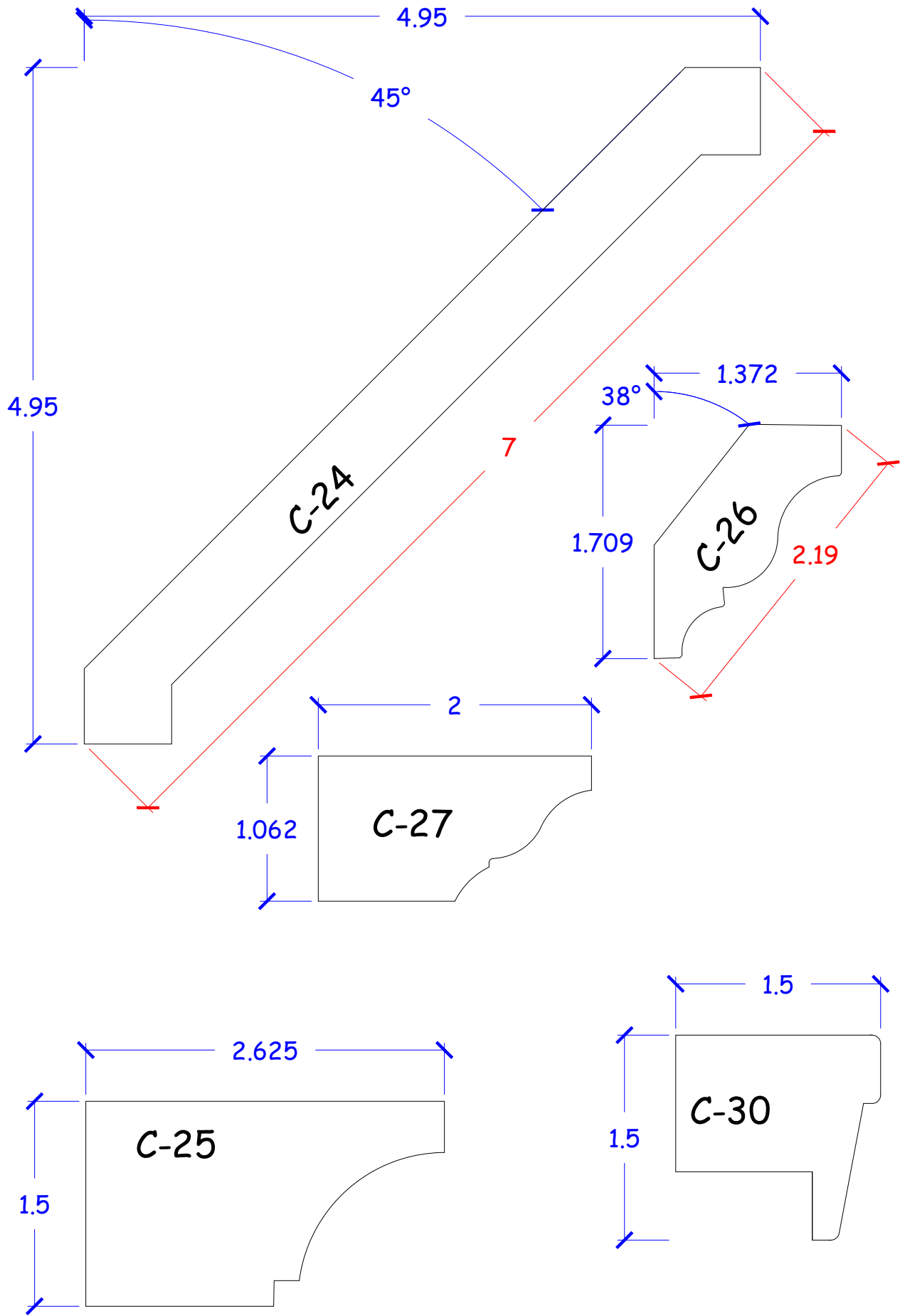

# CROWN Patterns

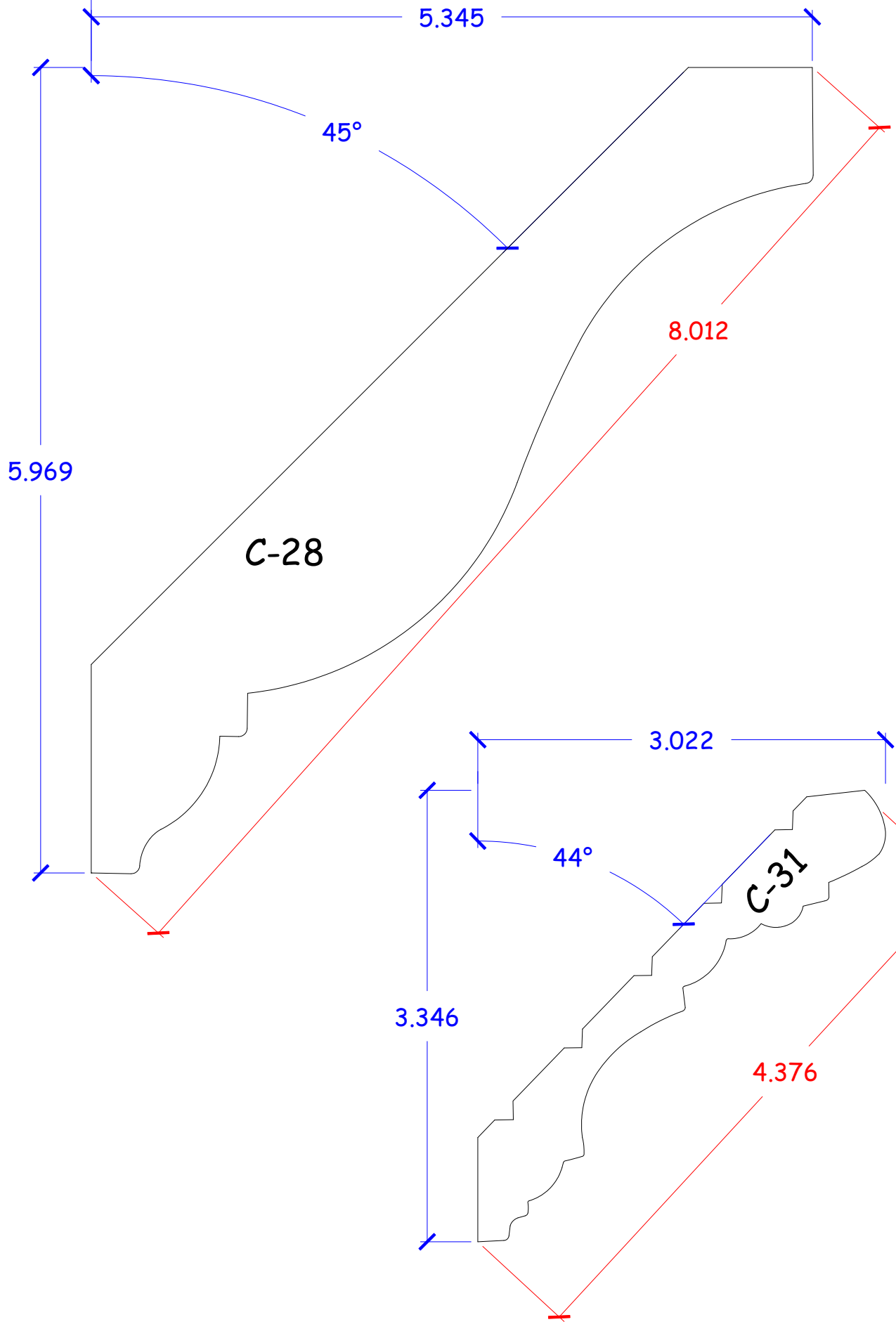

# CROWN Patterns

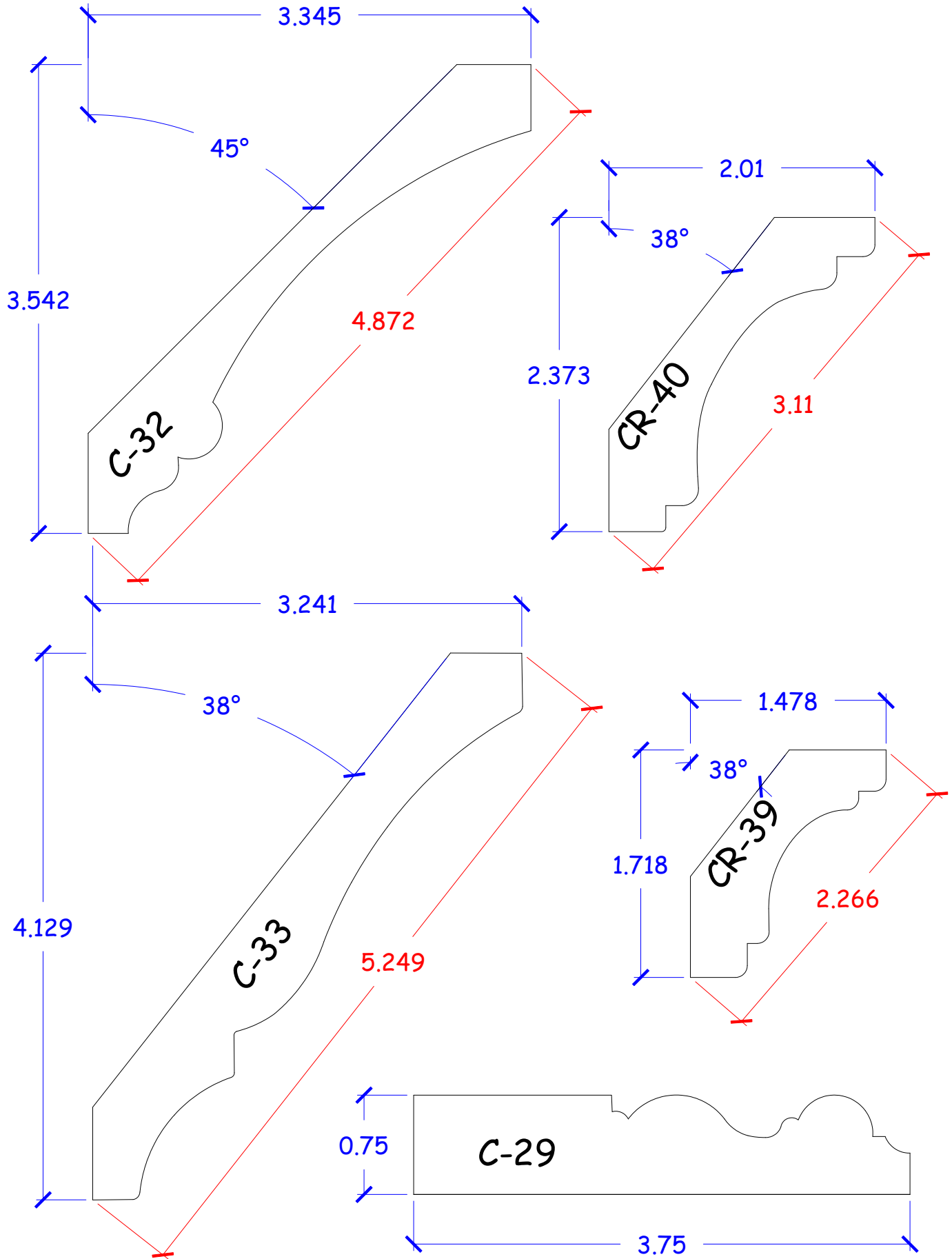

# CROWN Patterns

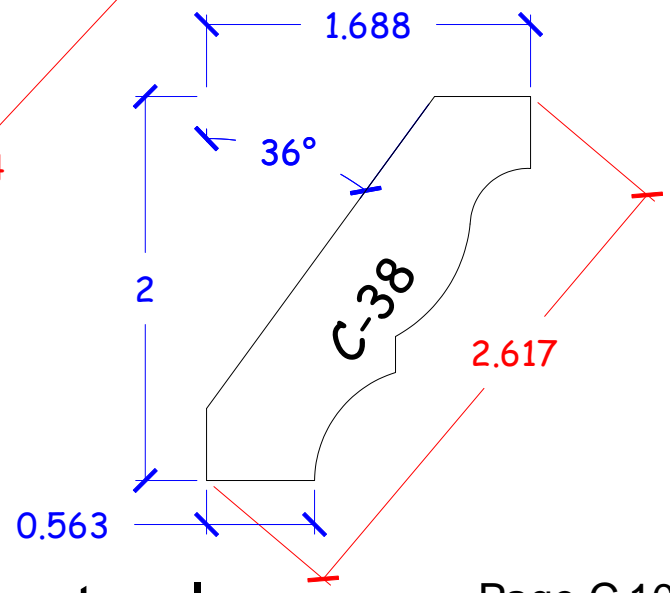
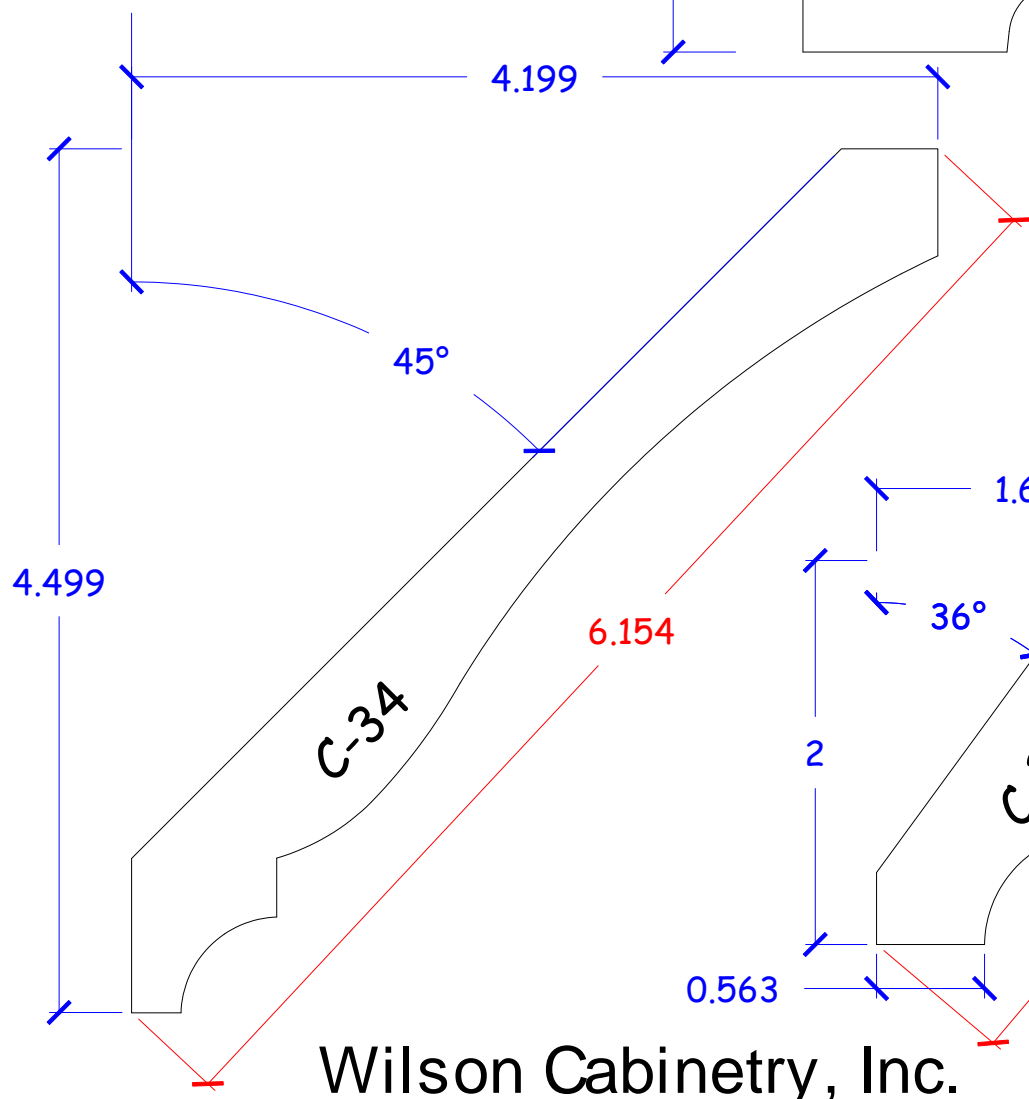
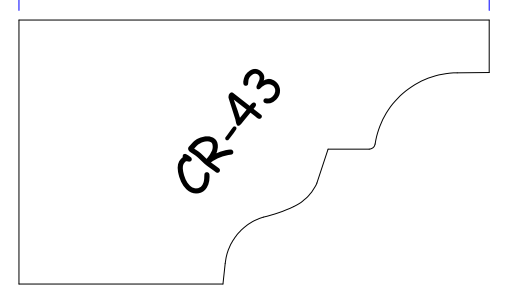
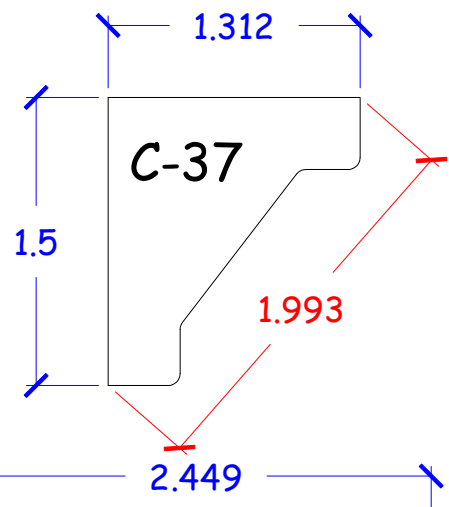
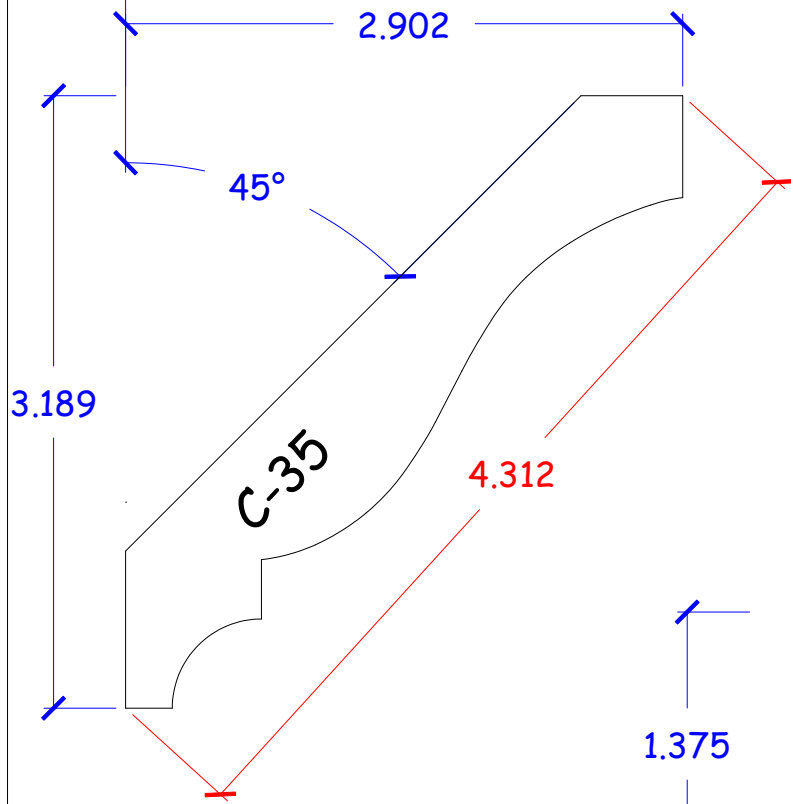

**Wilson Cabinetry, Inc.**

Page C-10

# CROWN Patterns

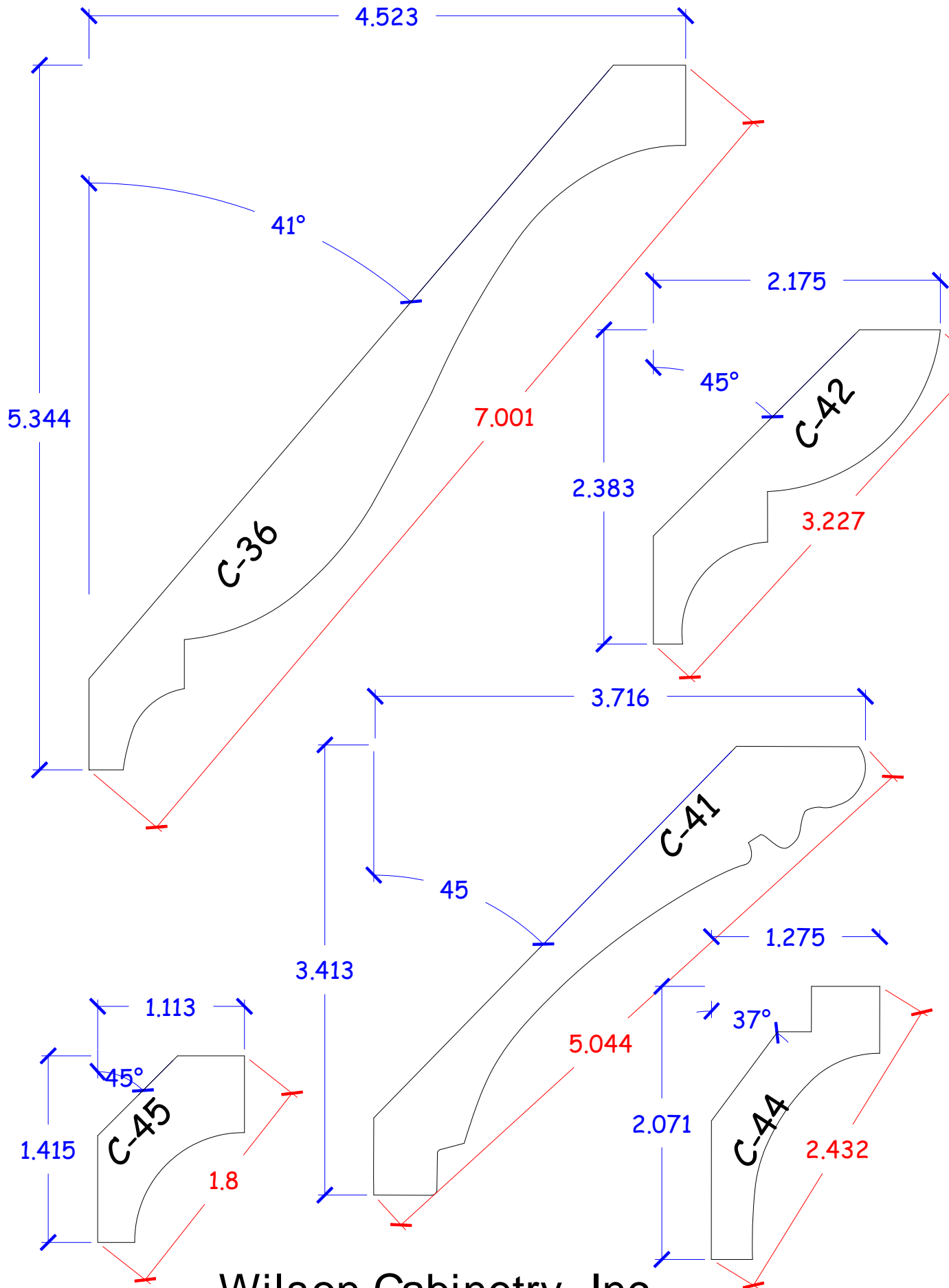

Wilson Cabinetry, Inc.

Page C-11

# CROWN Patterns

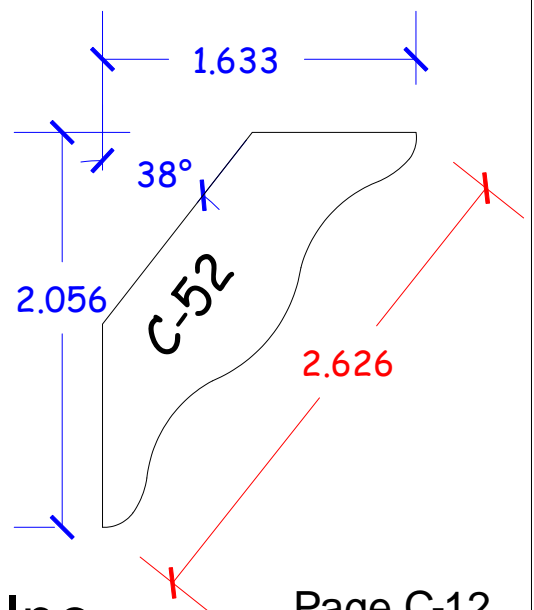
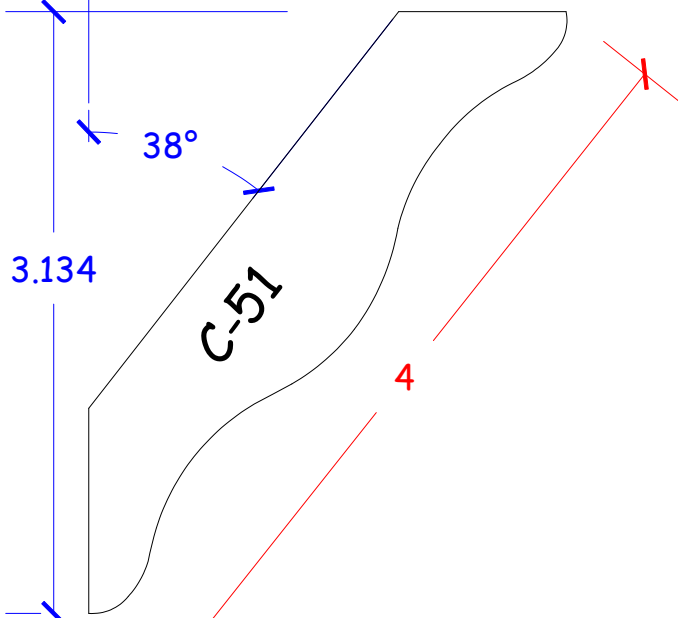
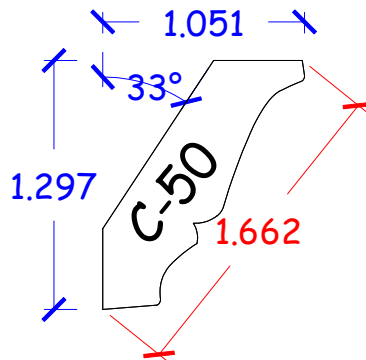
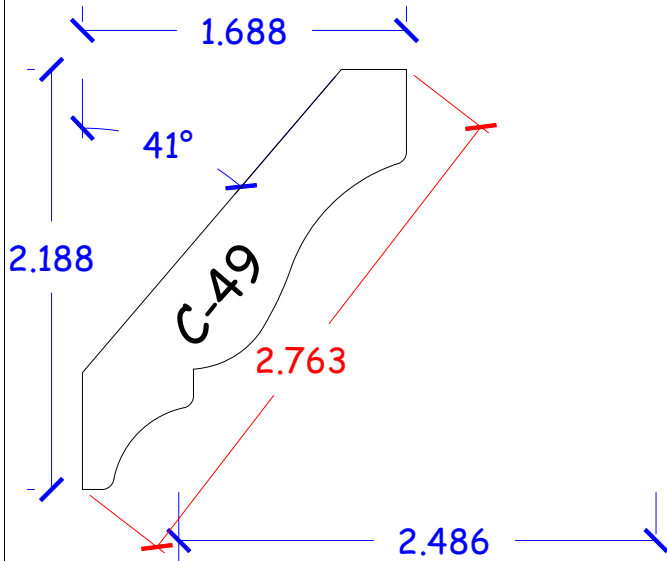
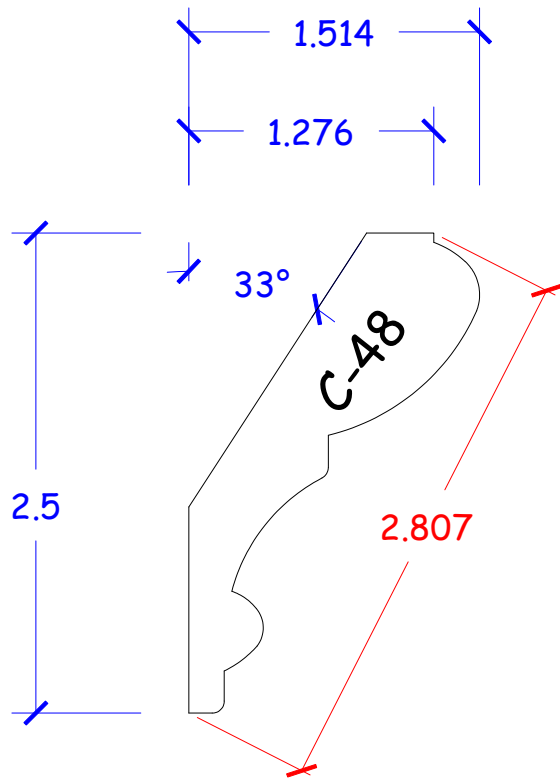
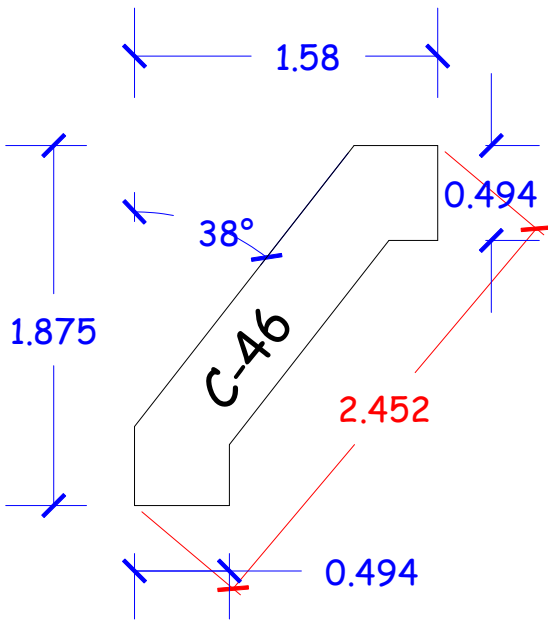



# CROWN Patterns

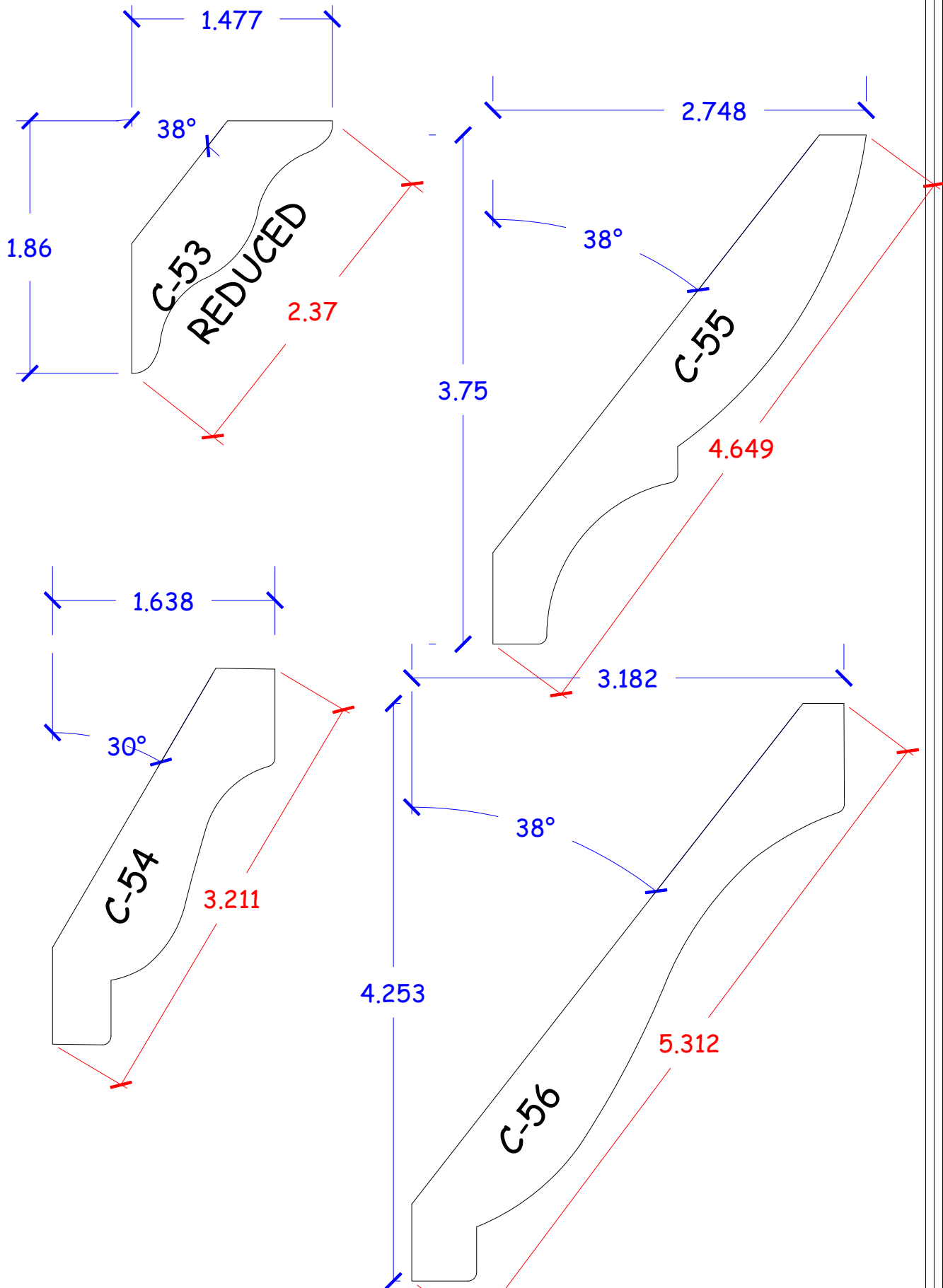

# CROWN Patterns

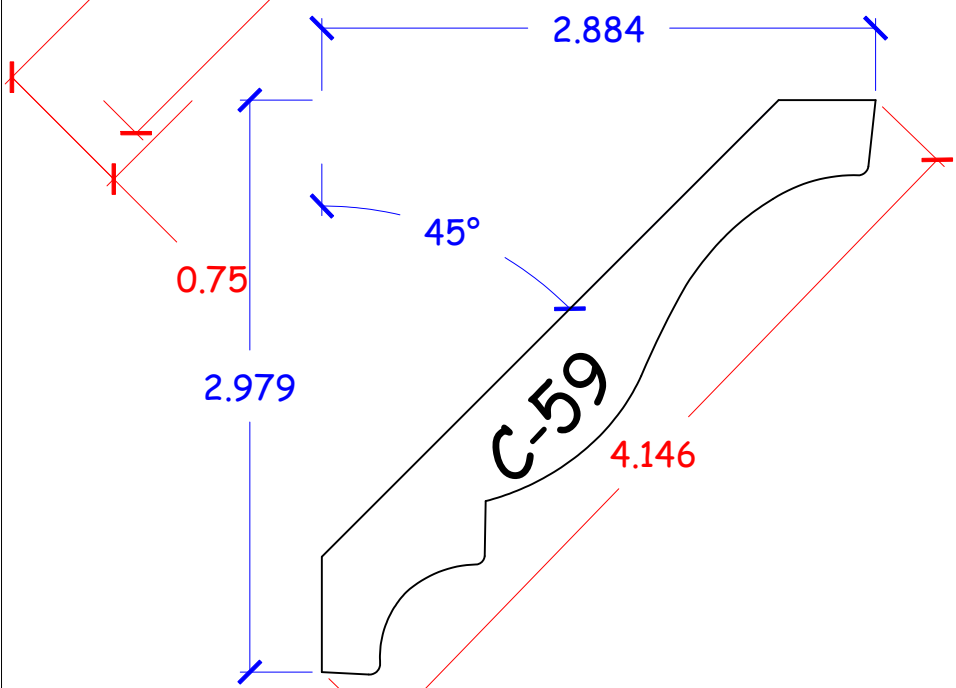
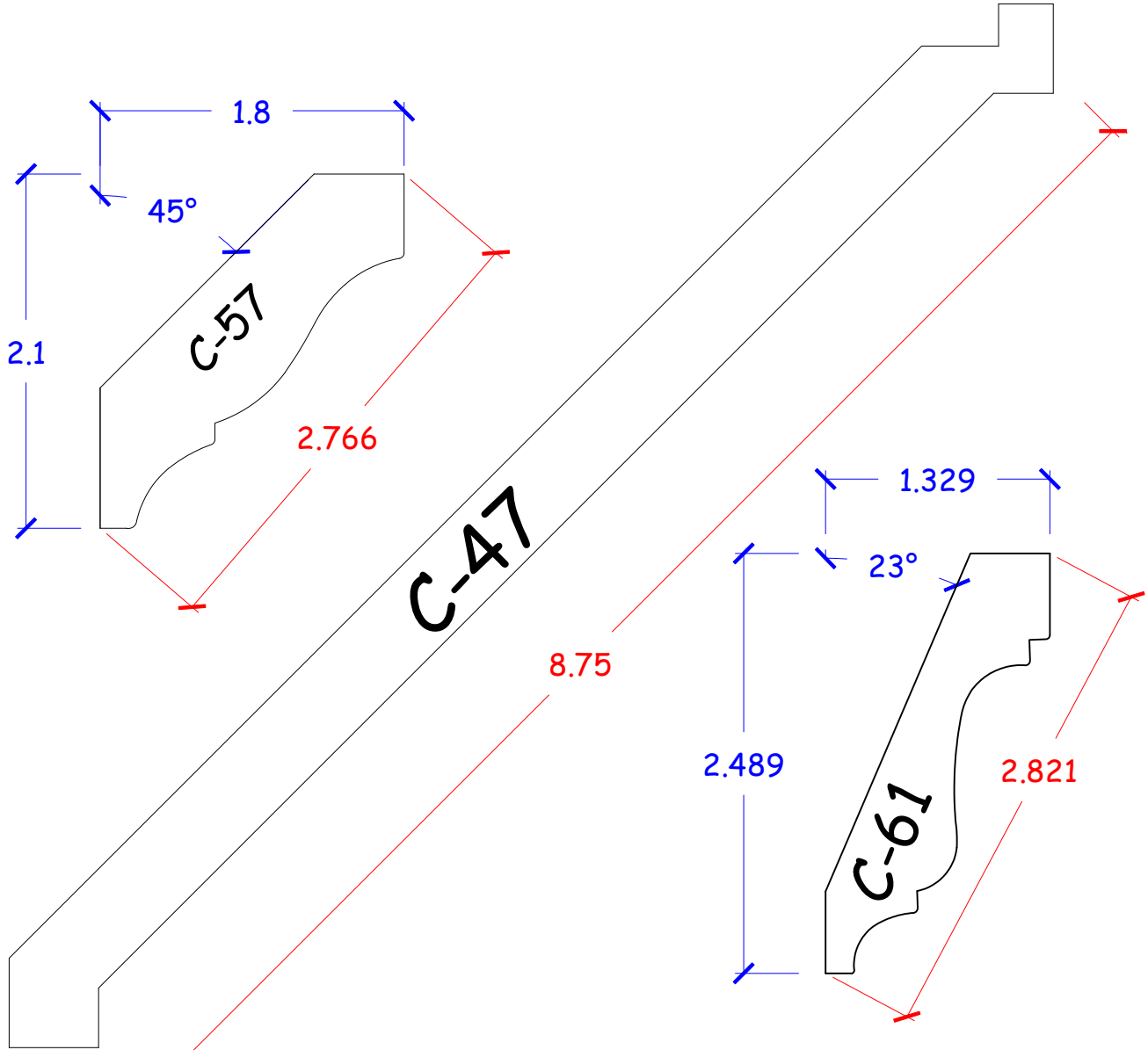
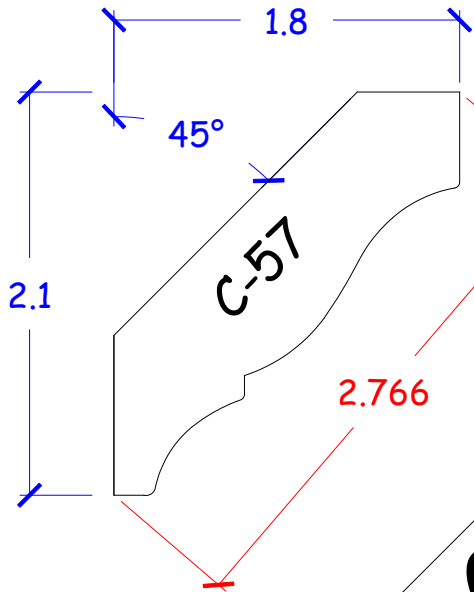

**Wilson Cabinetry, Inc.**

# CROWN Patterns

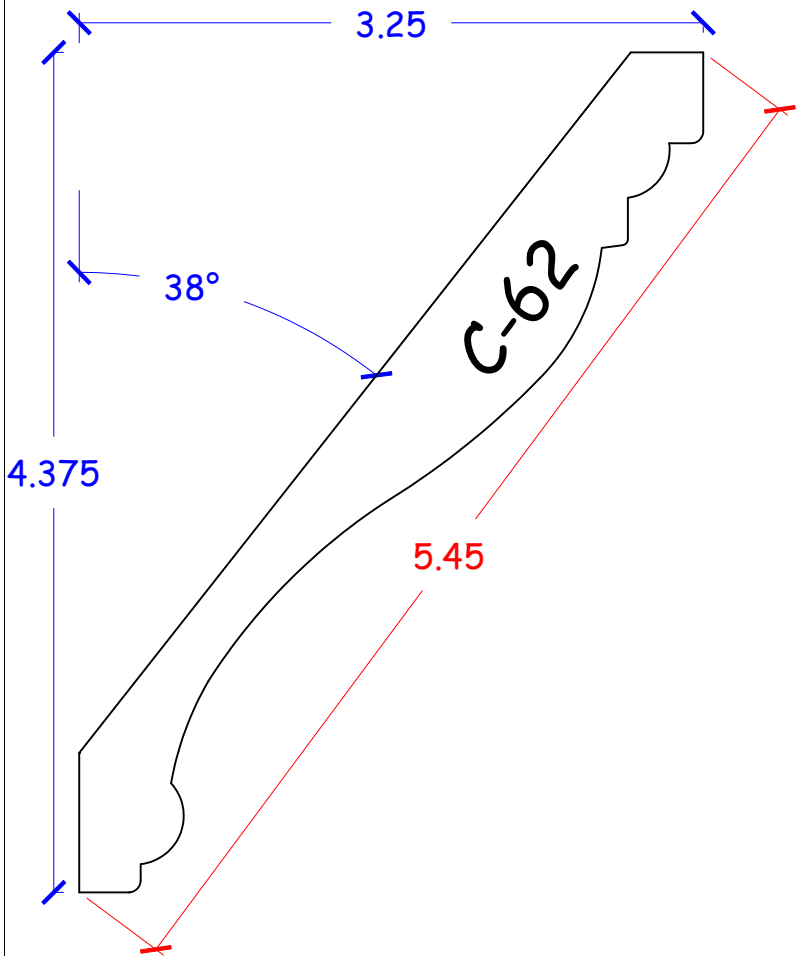
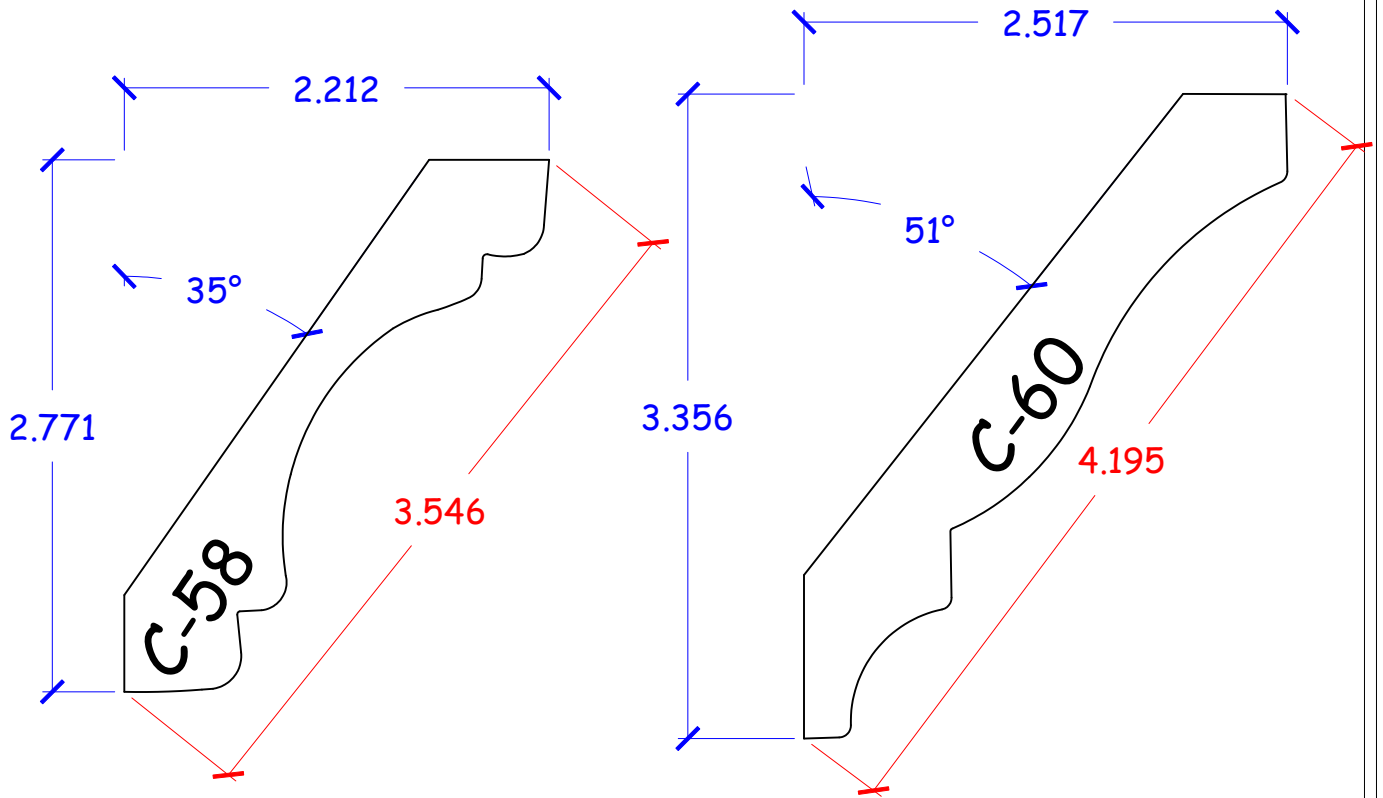

# CROWN Patterns

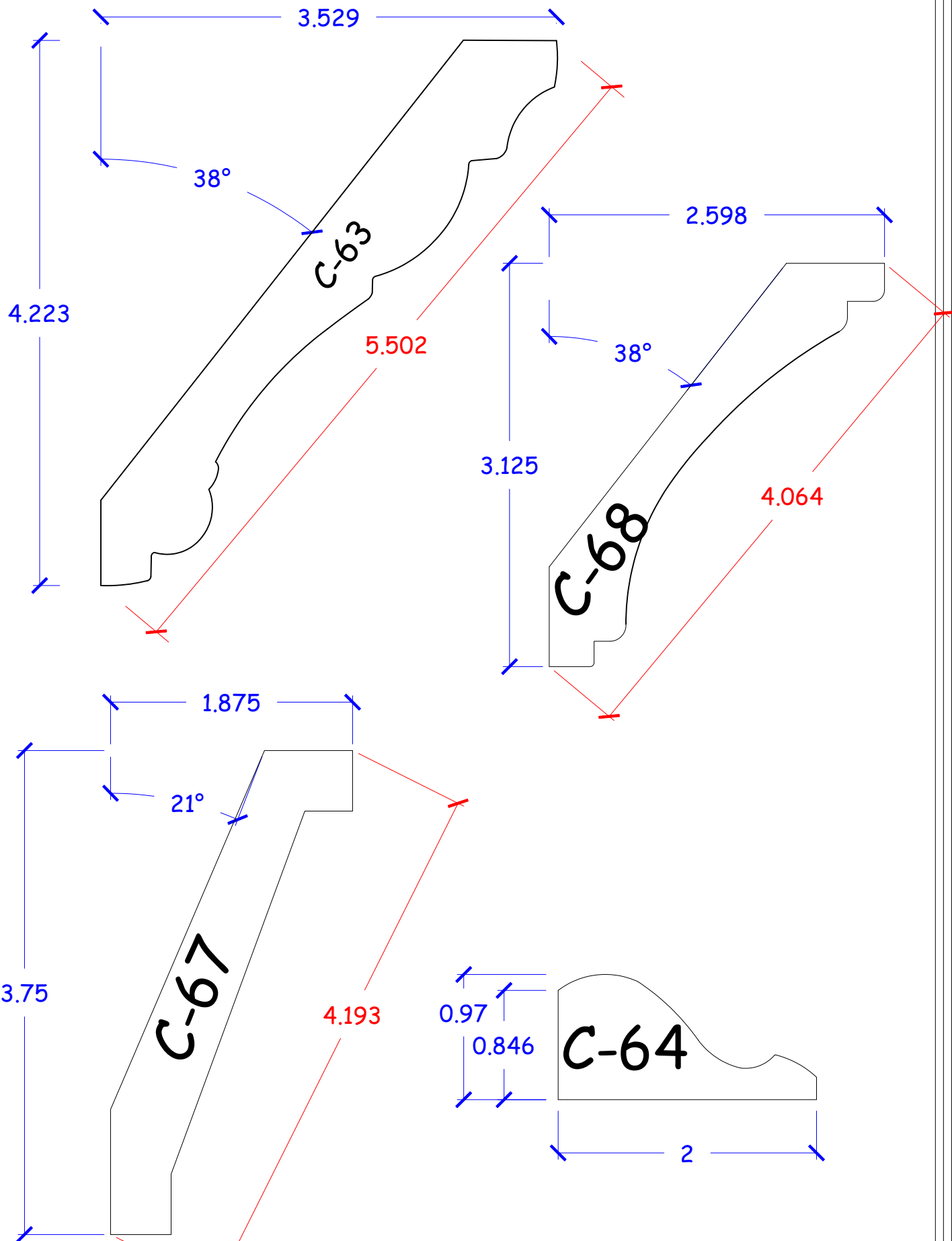

**Wilson Cabinetry, Inc.**

Page C-16

5046 Danford Dr  
Billings, MT 59106

(406) 652-4671 Phone  
(406) 652-1260 Fax

# CROWN Patterns

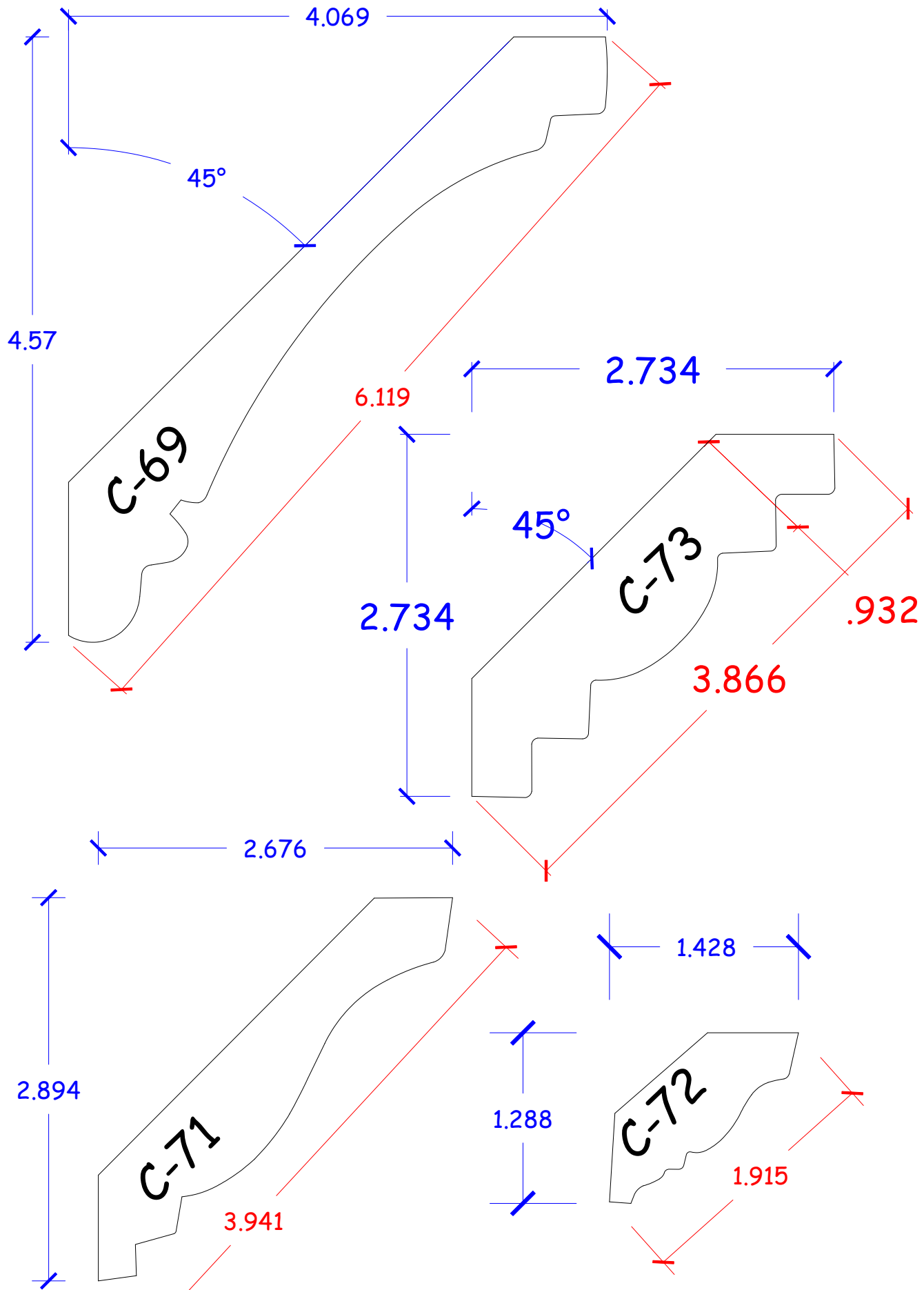

**Wilson Cabinetry, Inc.**

Page C-17

5046 Danford Dr  
Billings, MT 59106

(406) 652-4671 Phone  
(406) 652-1260 Fax

# CROWN Patterns

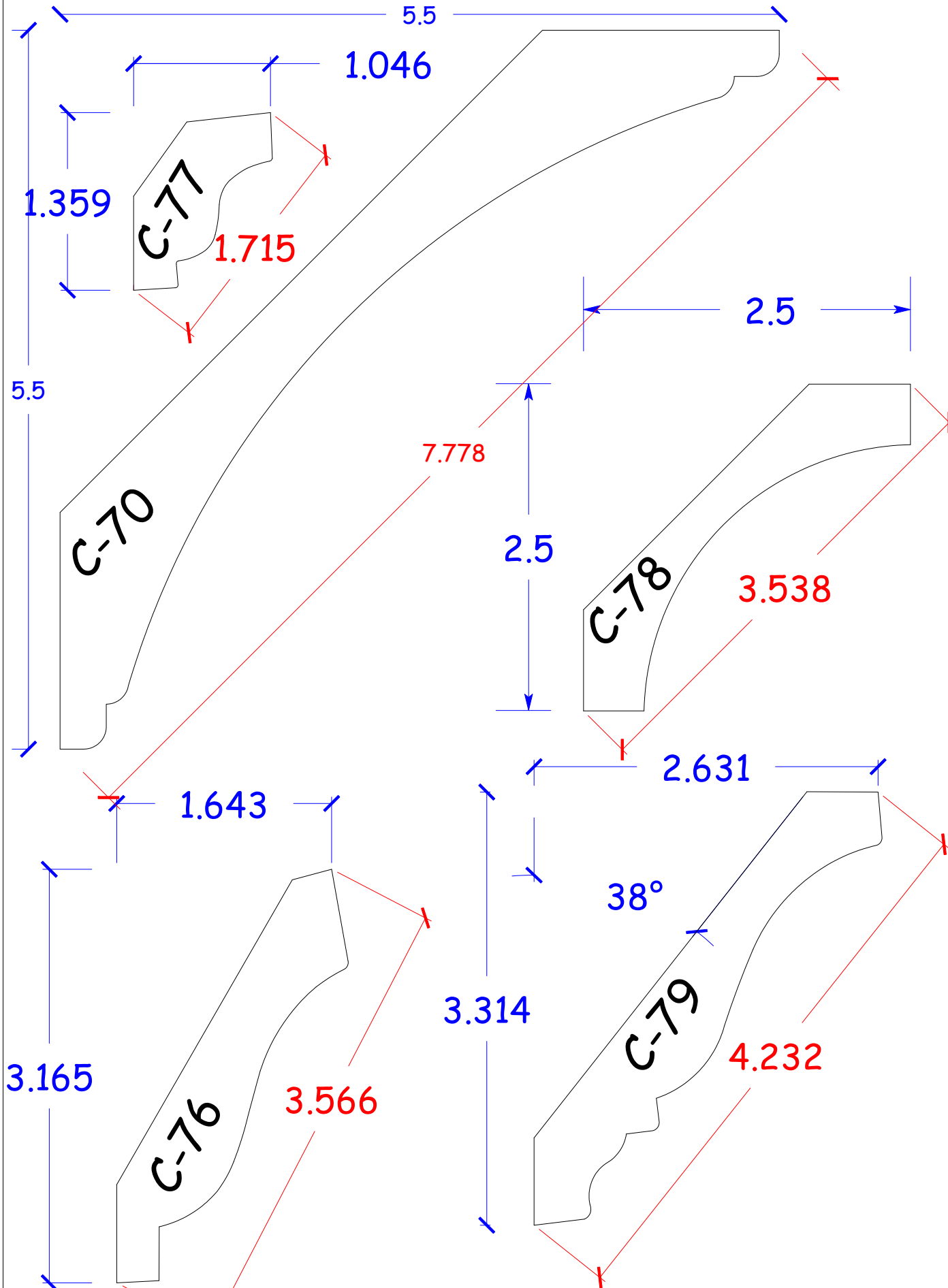

**Wilson Cabinetry, Inc.**

Page C-18

5046 Danford Dr  
Billings, MT 59106

(406) 652-4671 Phone  
(406) 652-1260 Fax

# CROWN Patterns

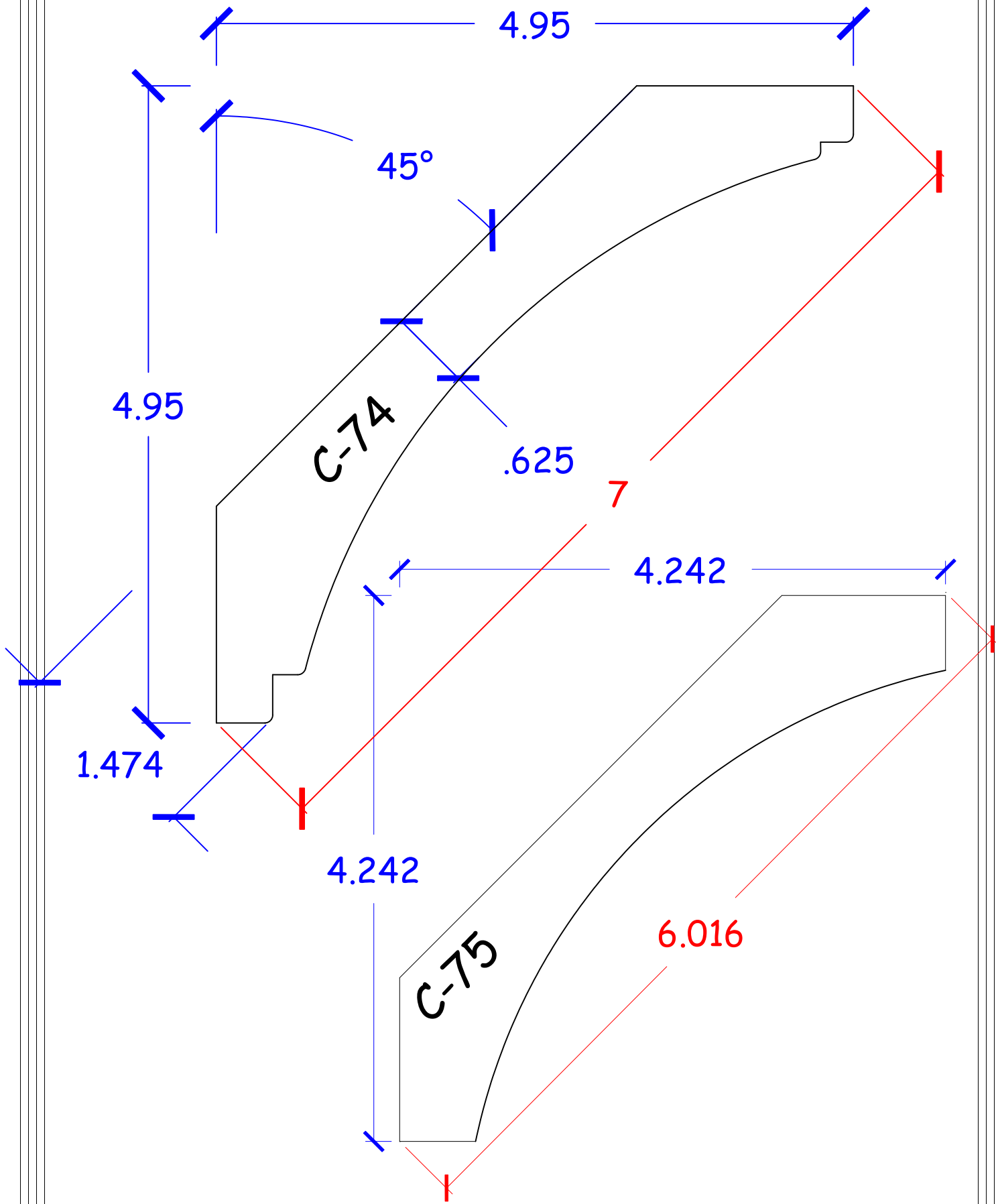

# CROWN Patterns

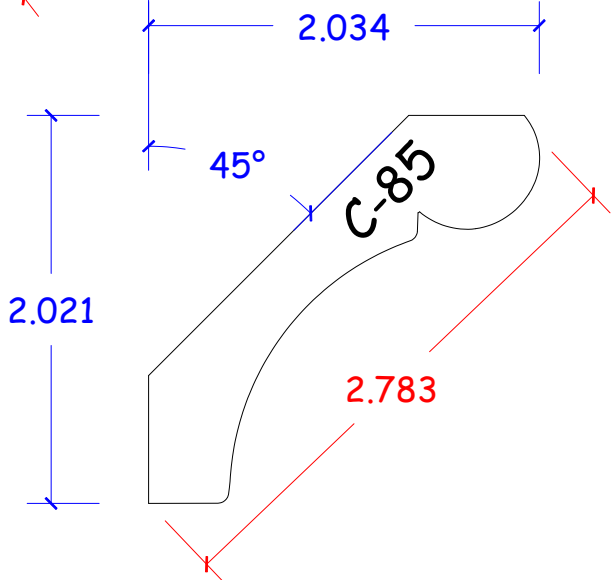
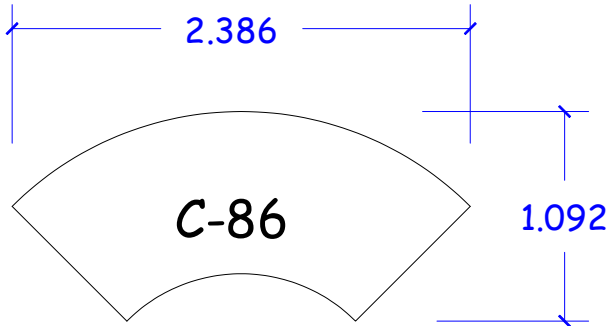
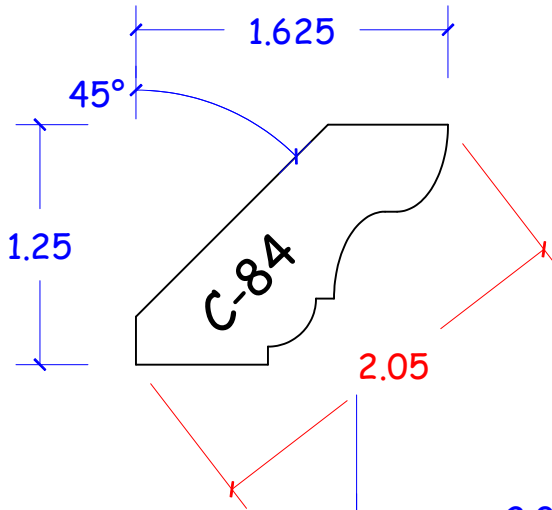
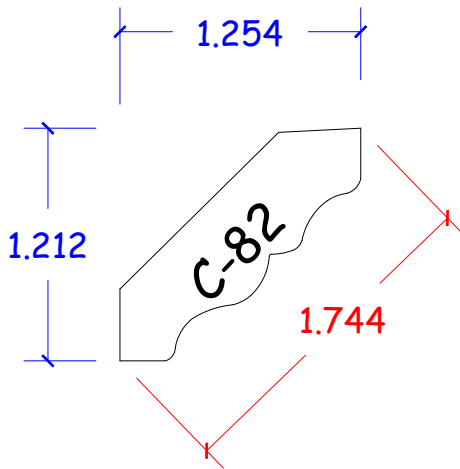
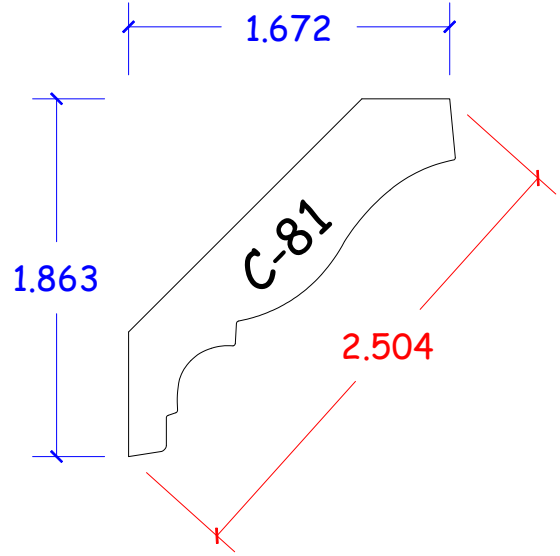
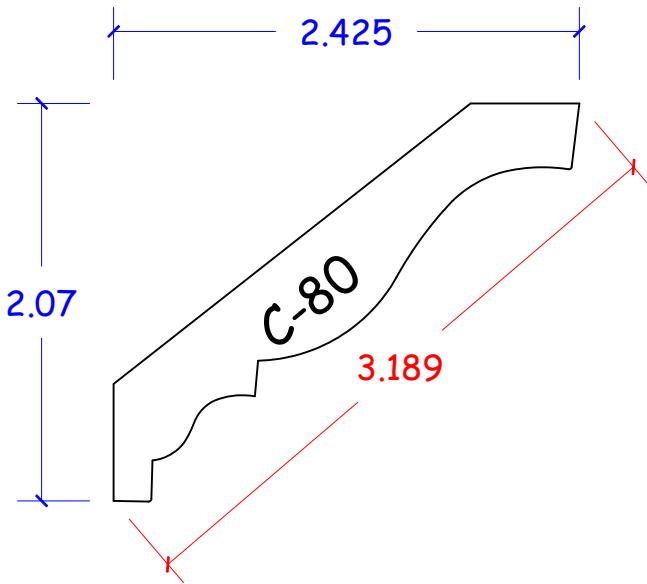



# CROWN Patterns

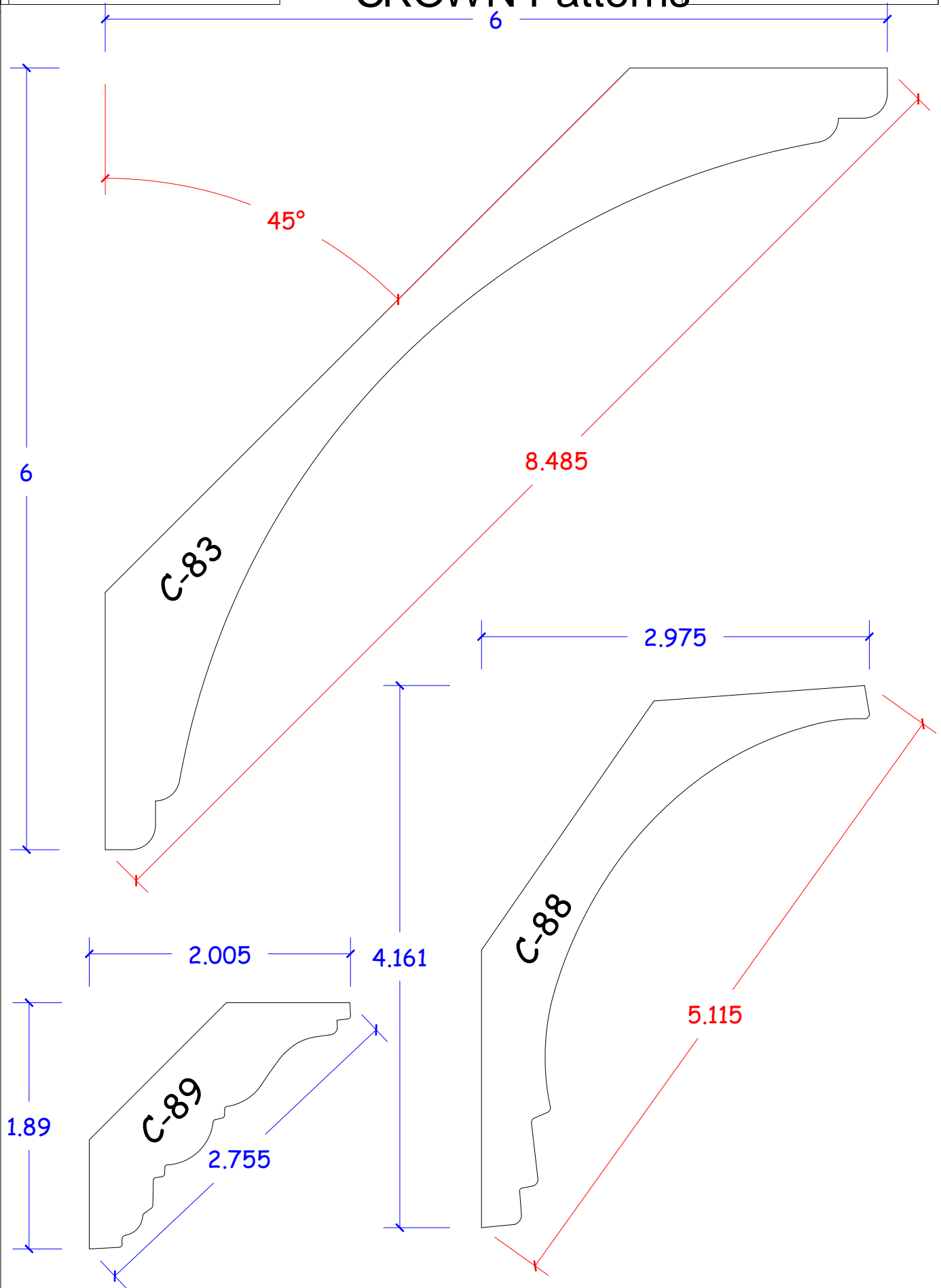

# CROWN Patterns

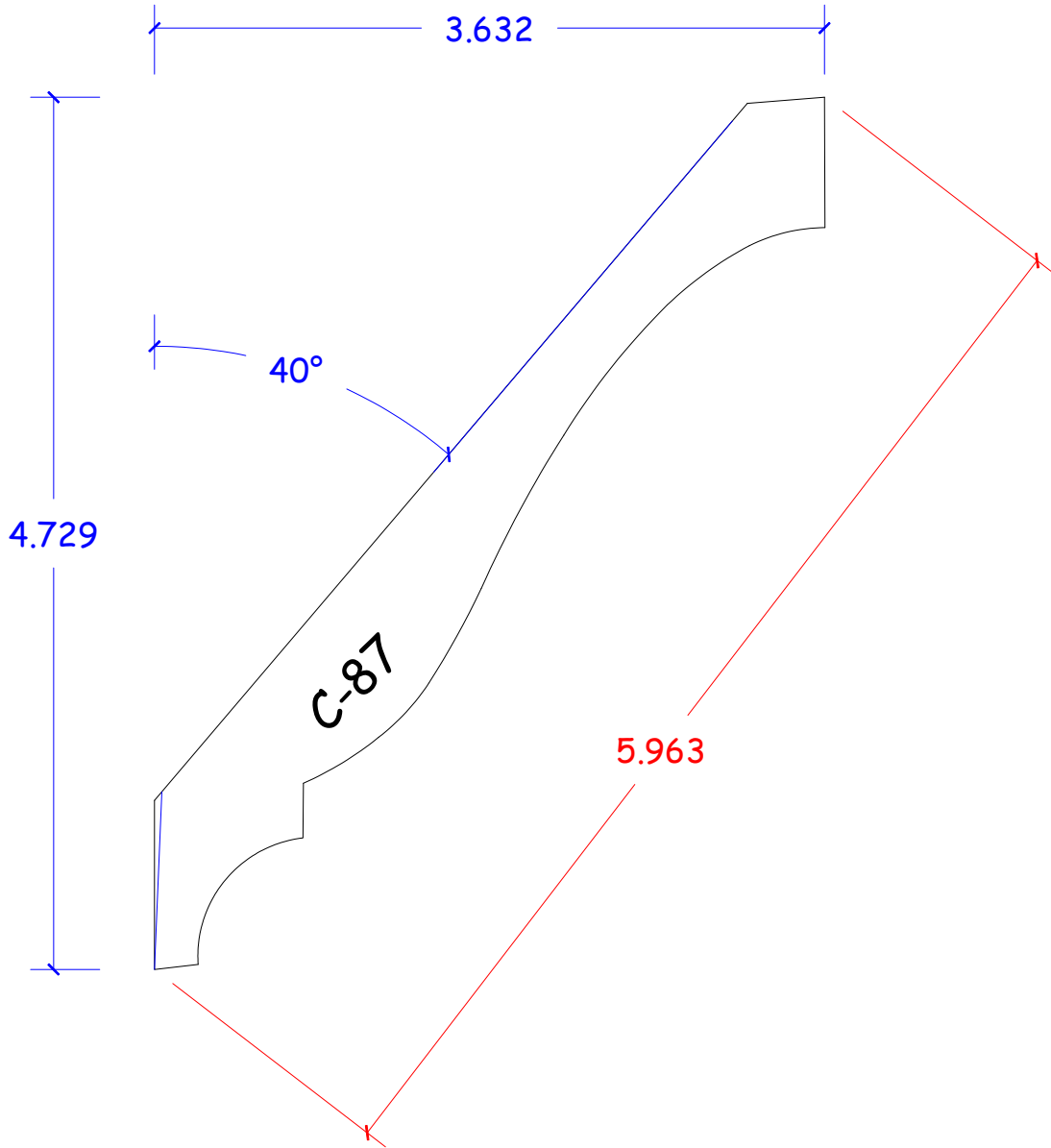

# Hand & Barrails

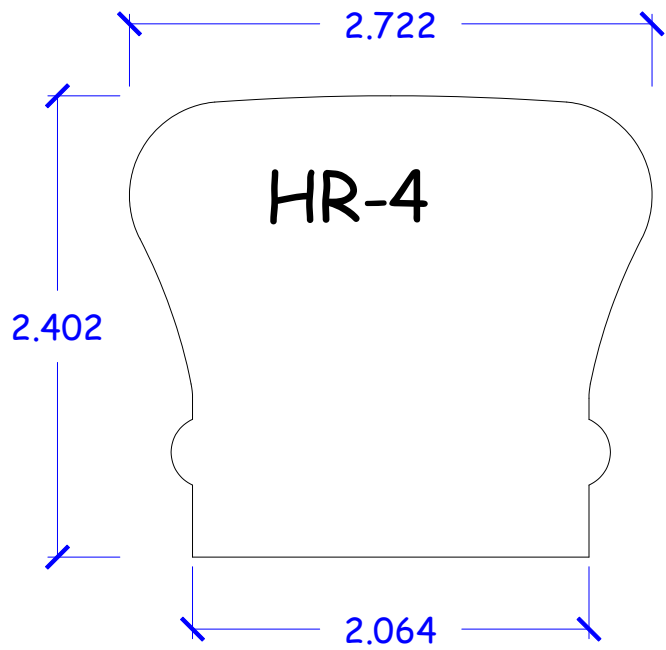
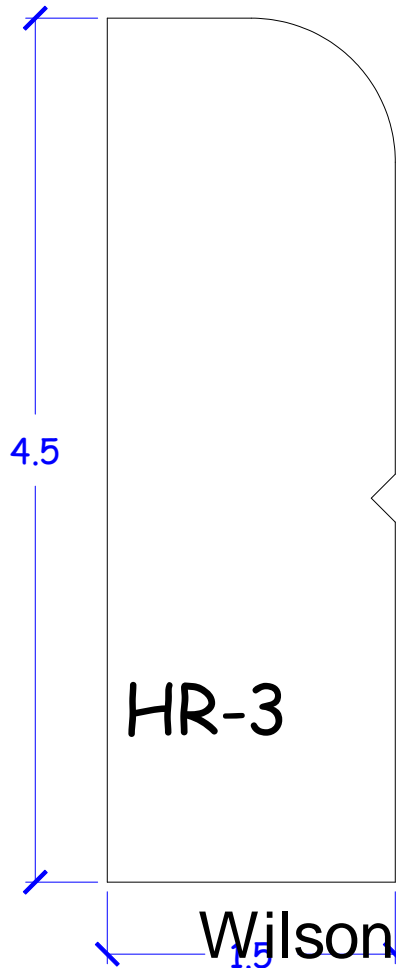
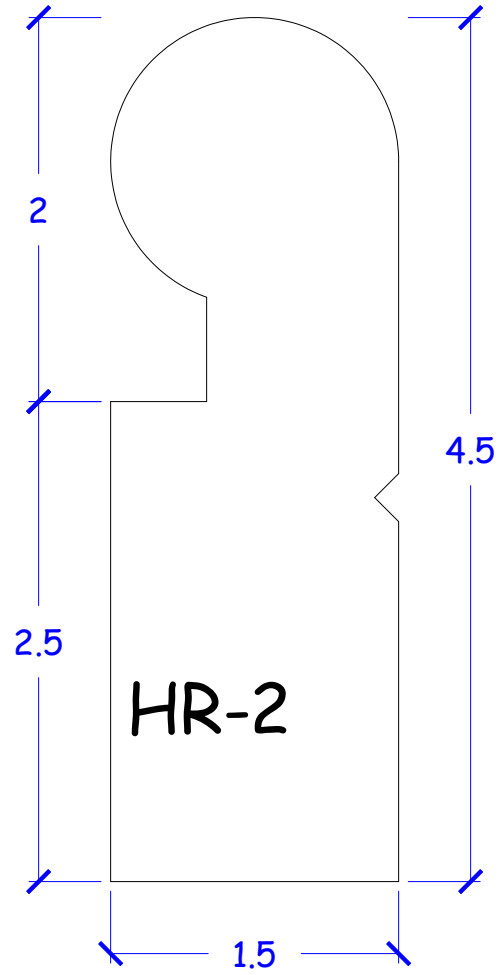
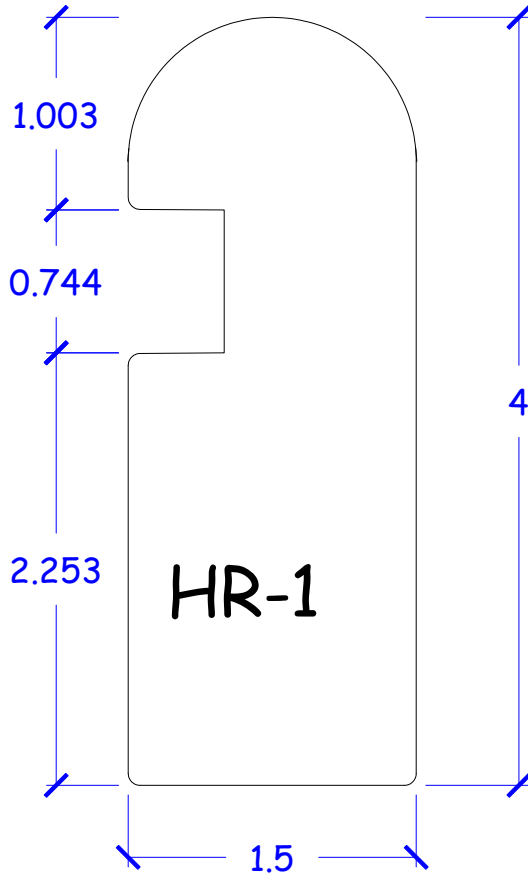

# Hand & Barrails

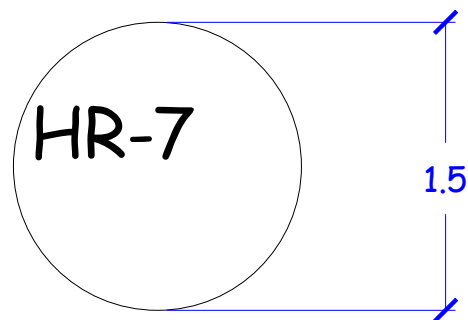
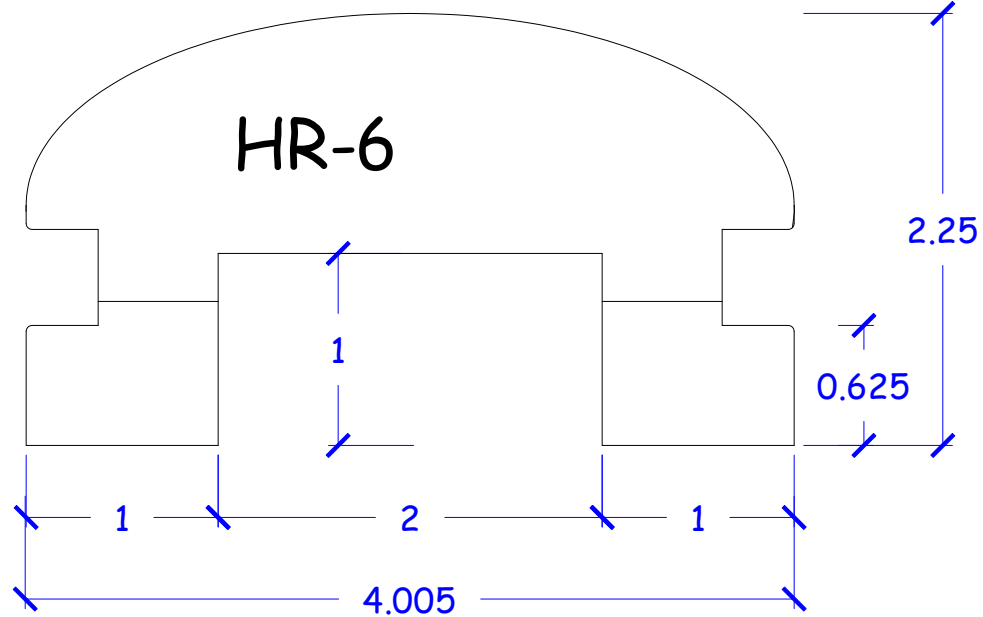
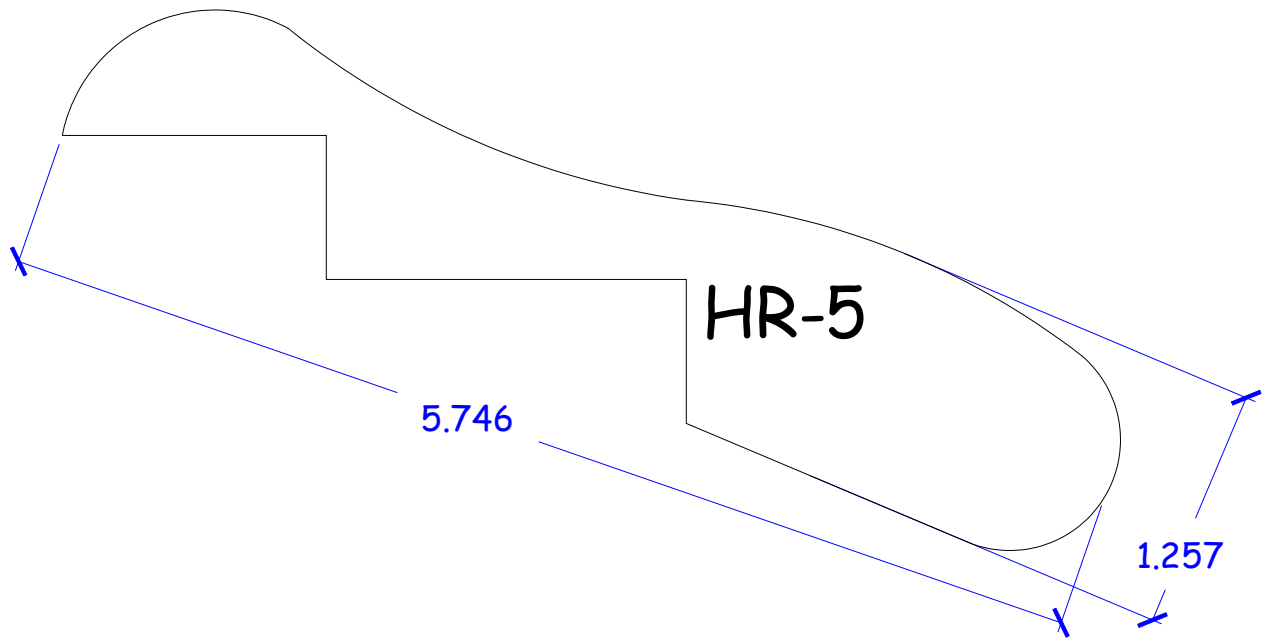

# Hand & Barrails

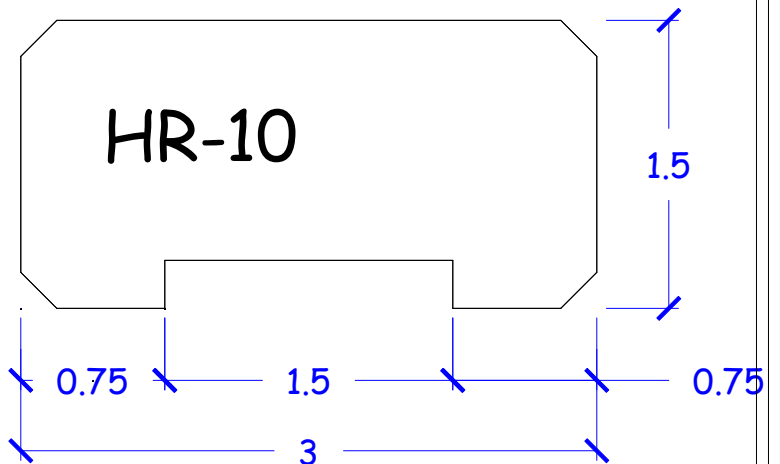
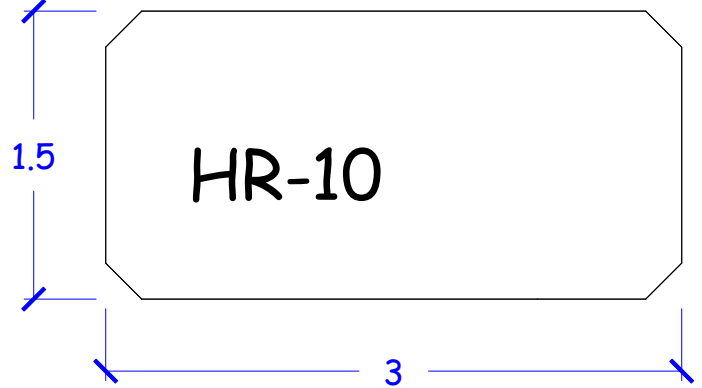
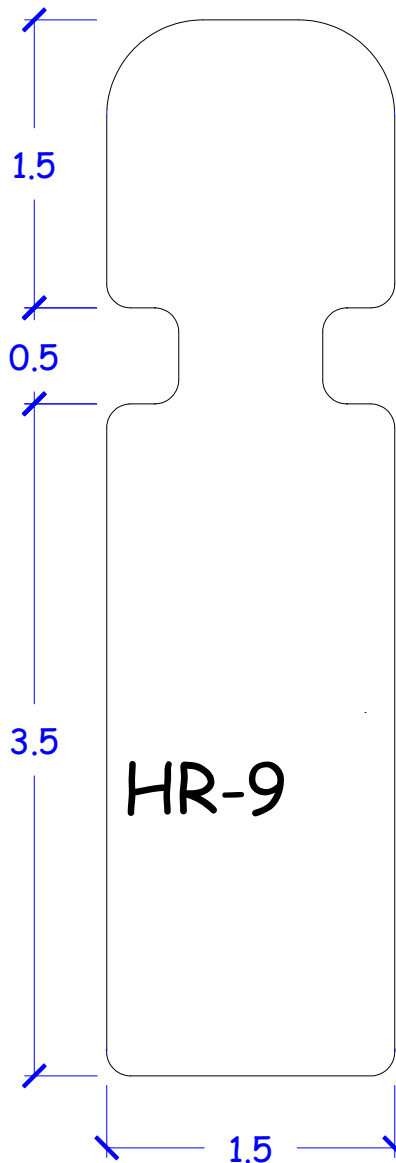
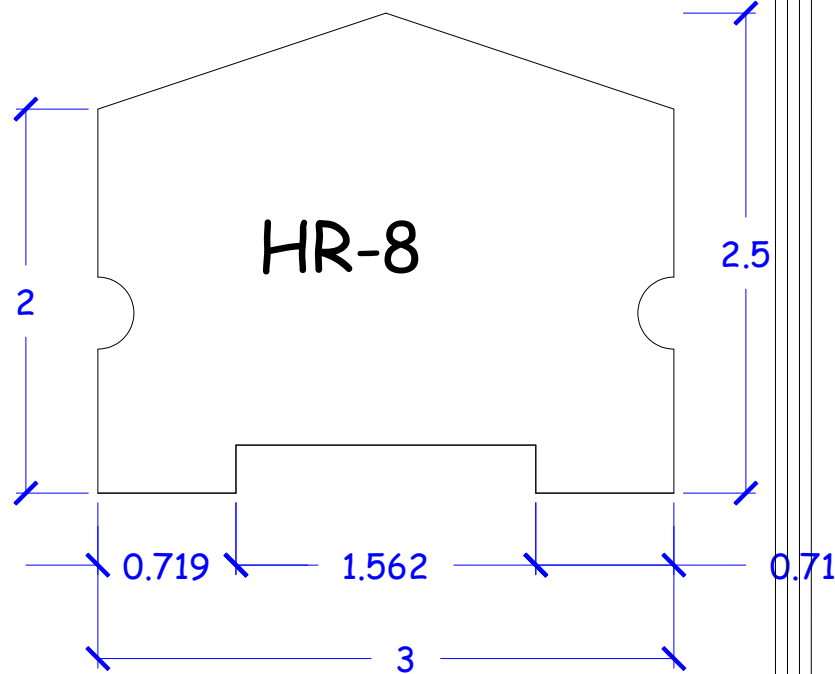
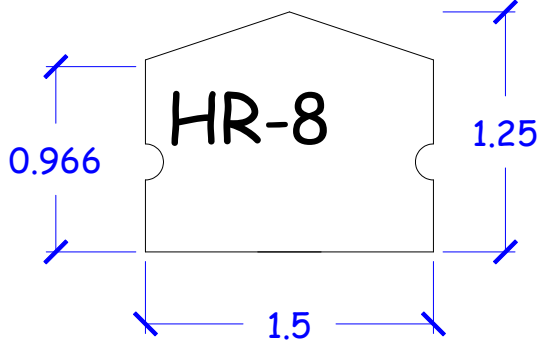

# Hand & Barrails

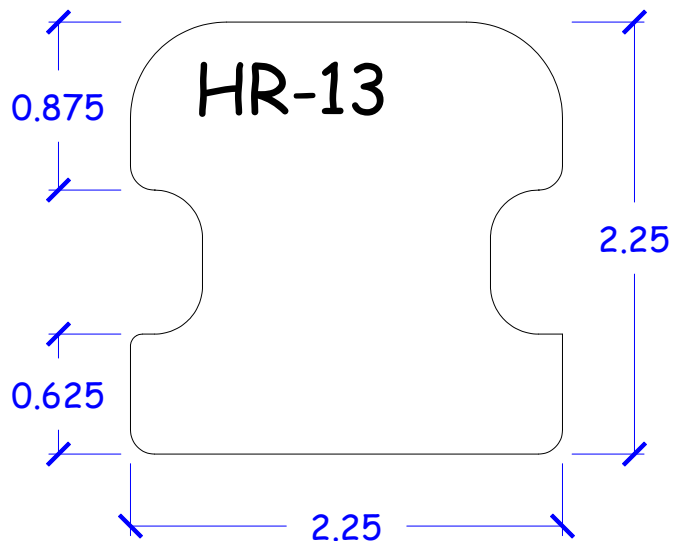
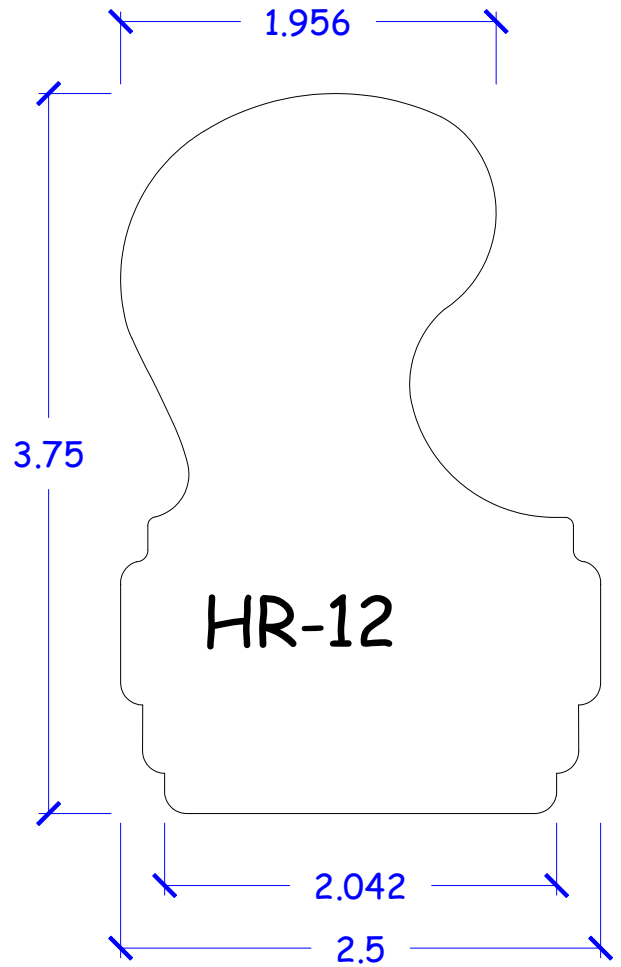
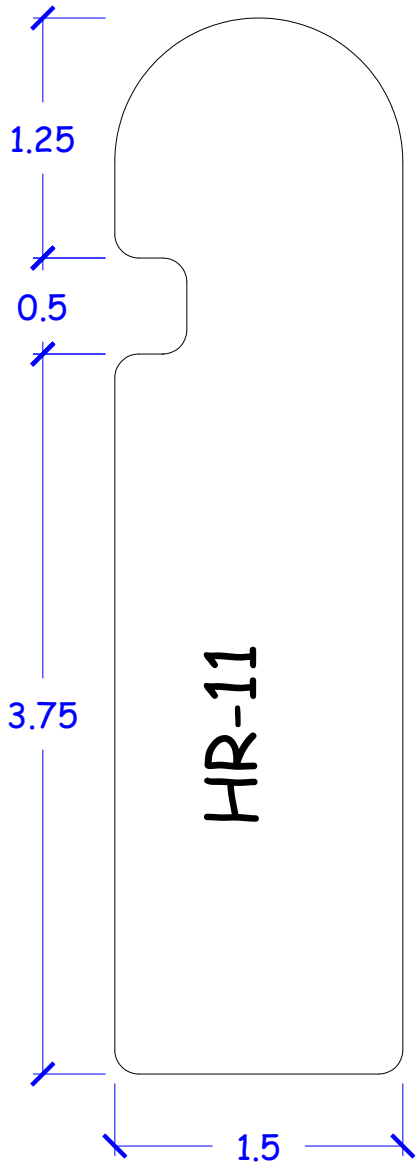

# Hand & Barrails

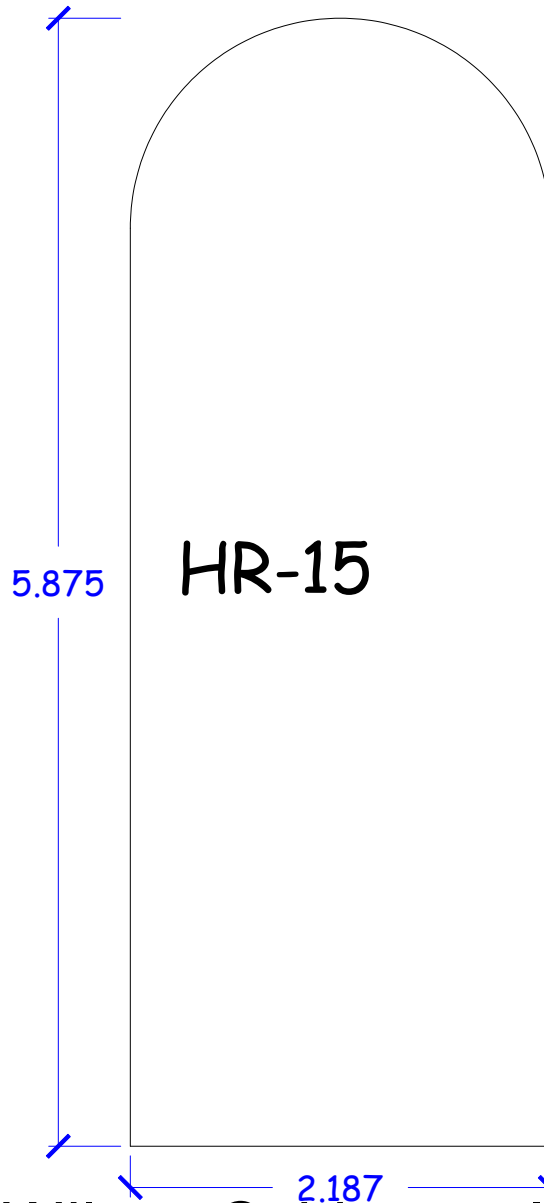
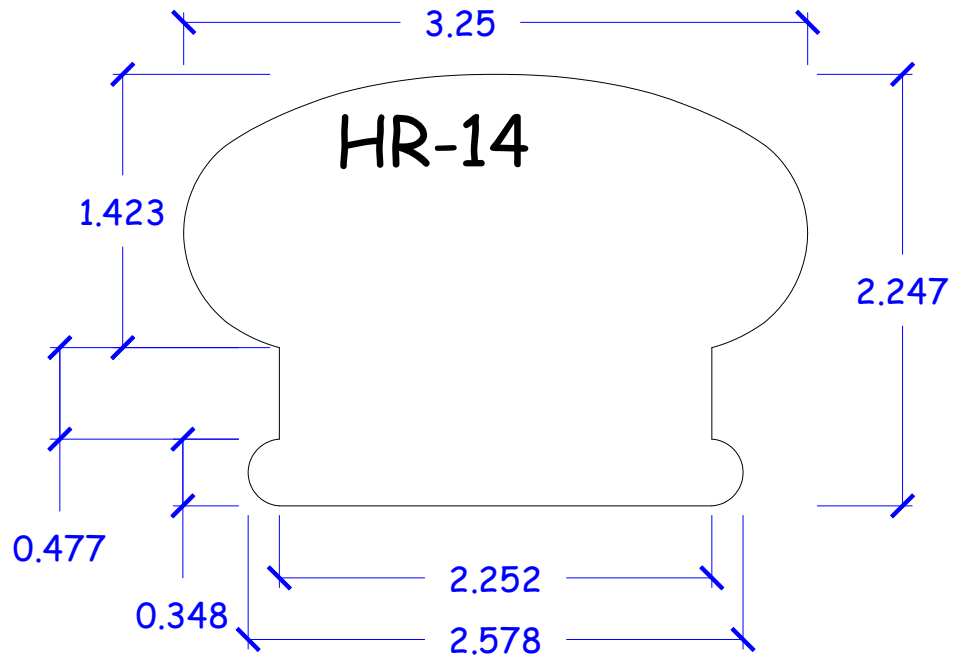

**Wilson Cabinetry, Inc.**

Page HR-5

# Hand & Barrails

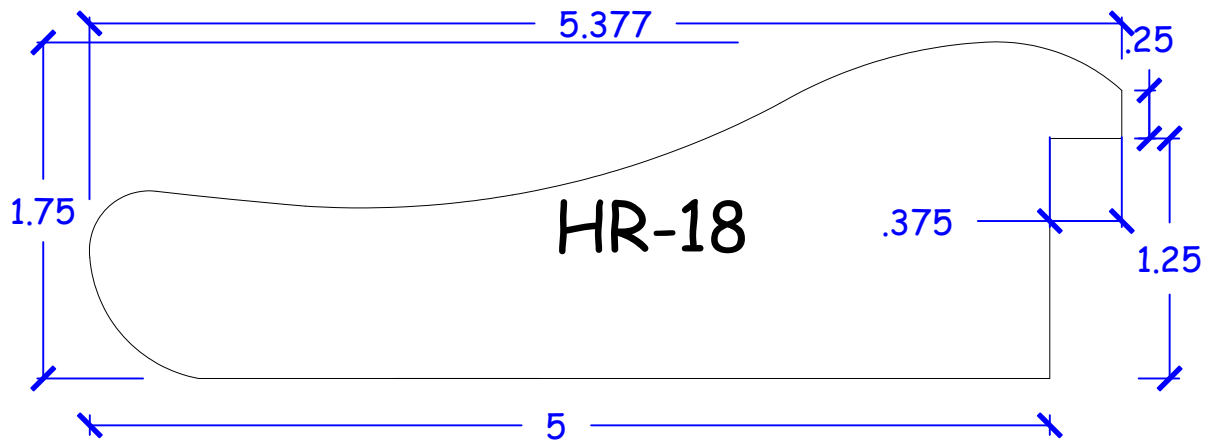
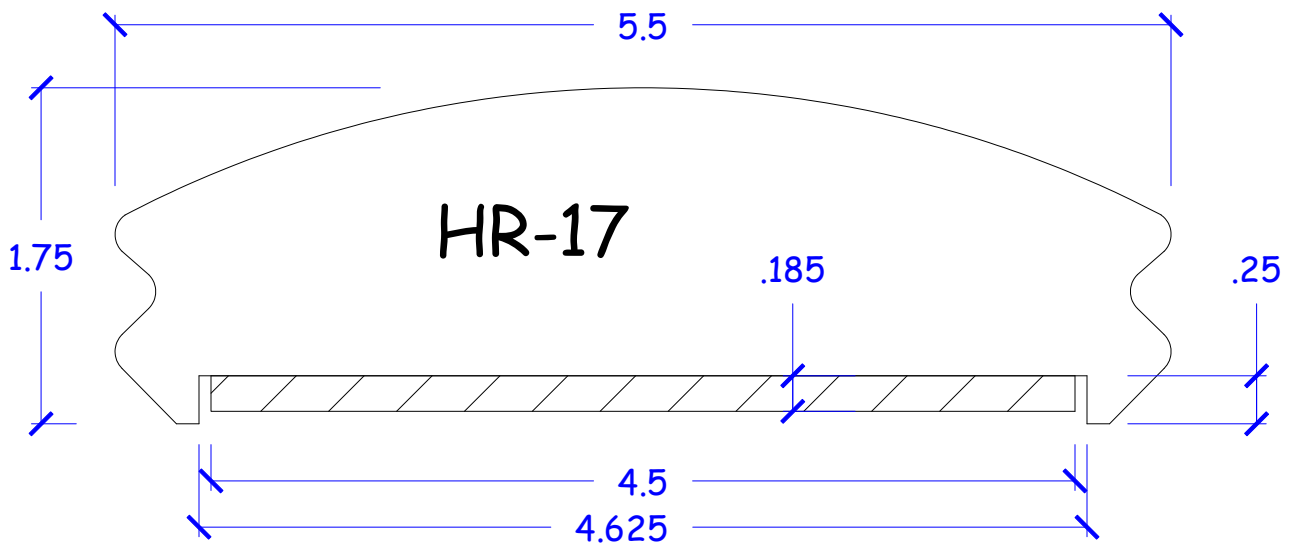
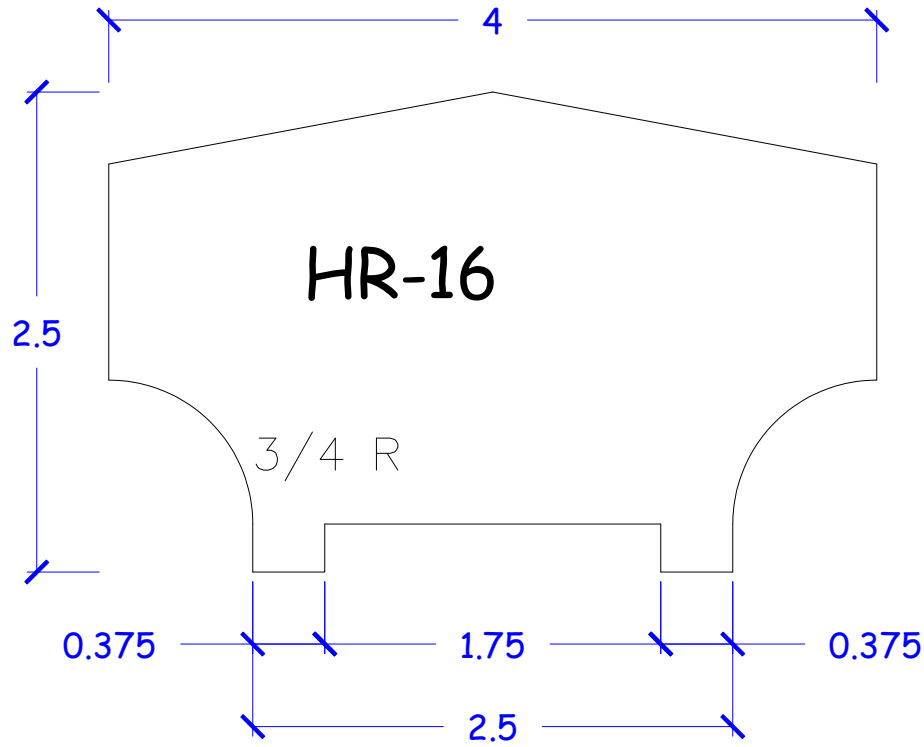

Wilson Cabinetry, Inc.

Page HR-6



# Hand & Barrails

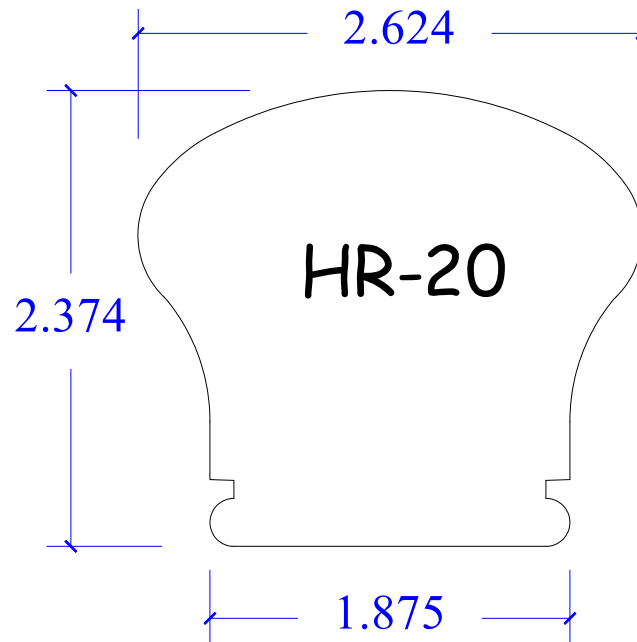
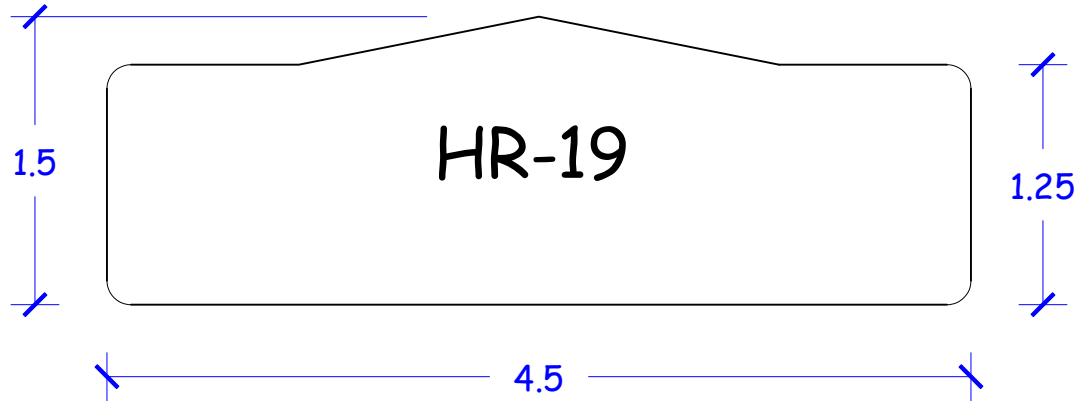

# MISC. Patterns

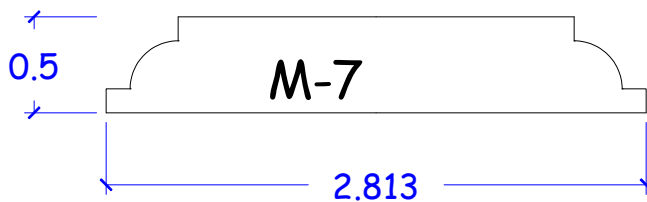
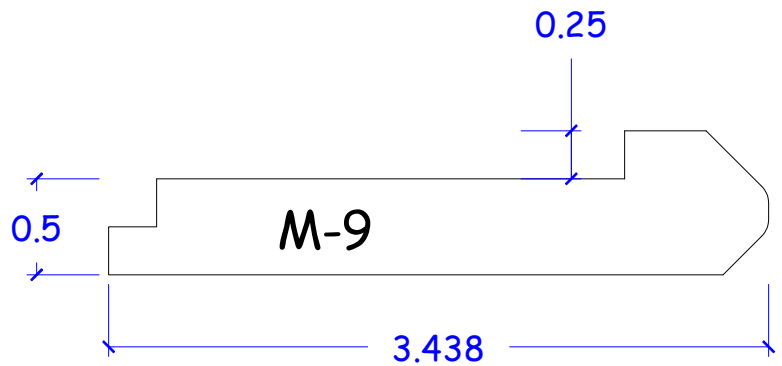
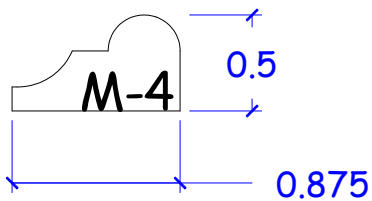
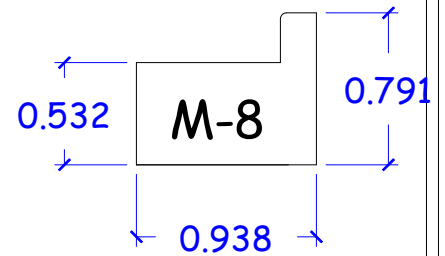
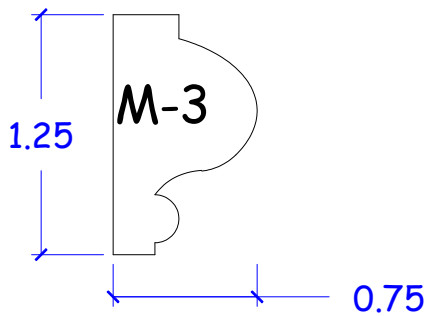
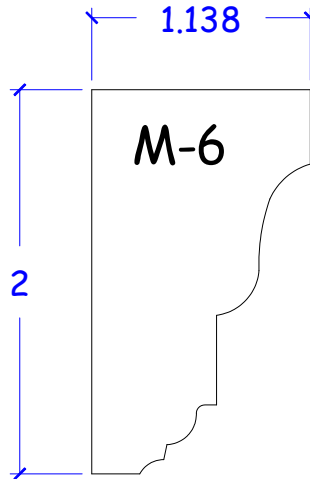
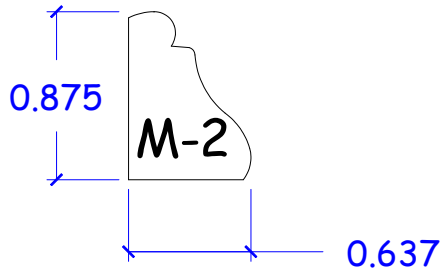
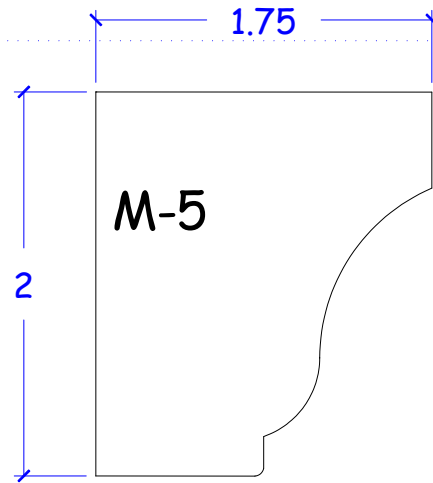
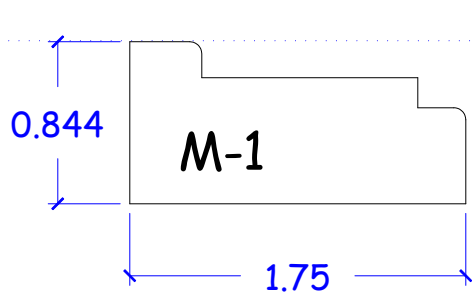

**Wilson Cabinetry, Inc.**

Page M-1

# MISC. Patterns

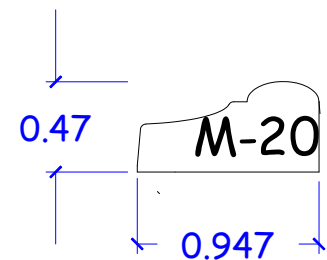
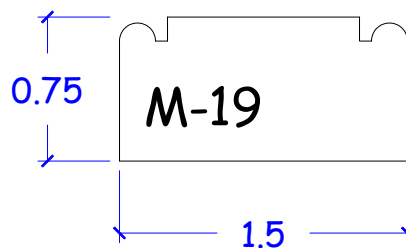
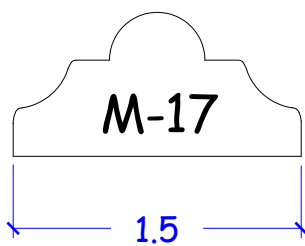
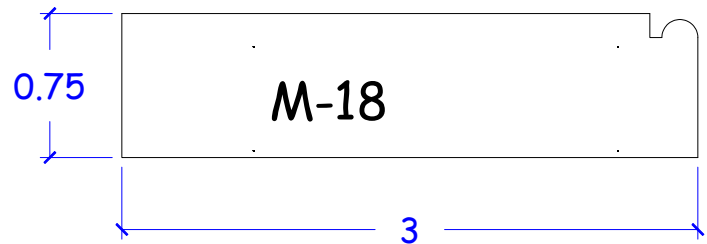
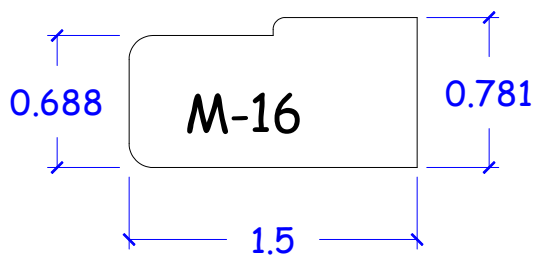
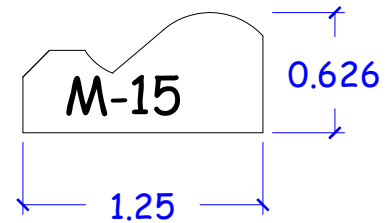
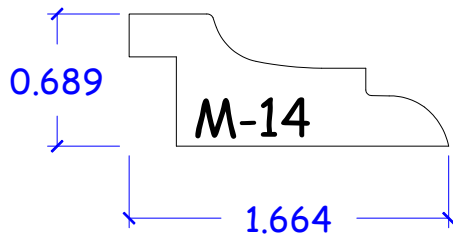
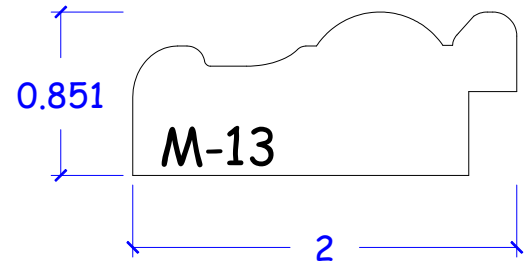
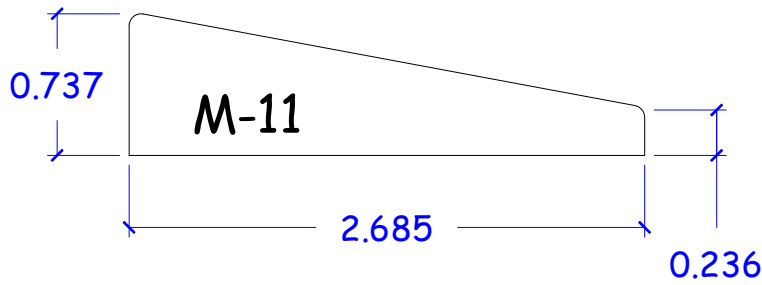
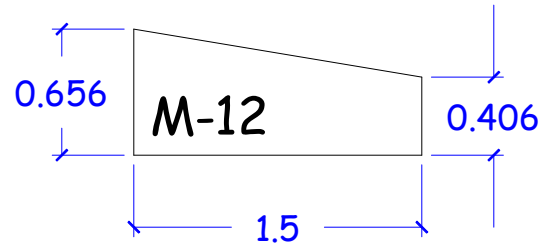
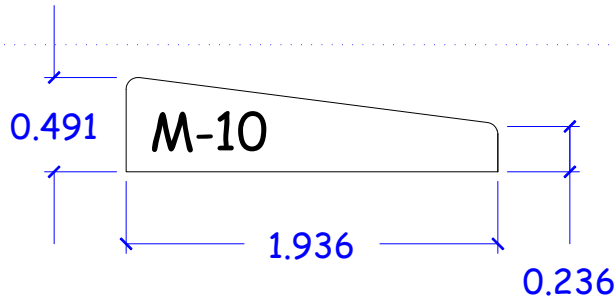

# MISC. Patterns

M-20, M

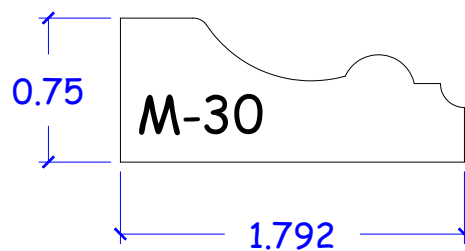
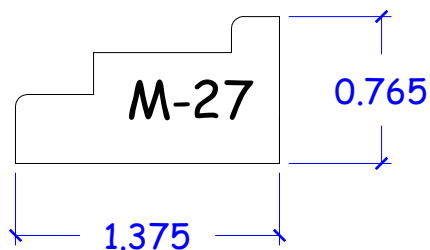
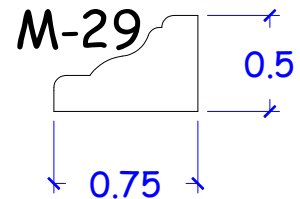
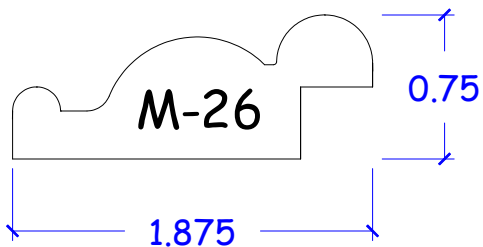
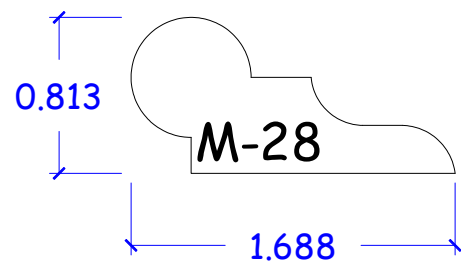
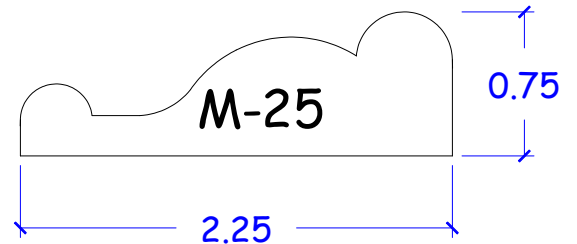
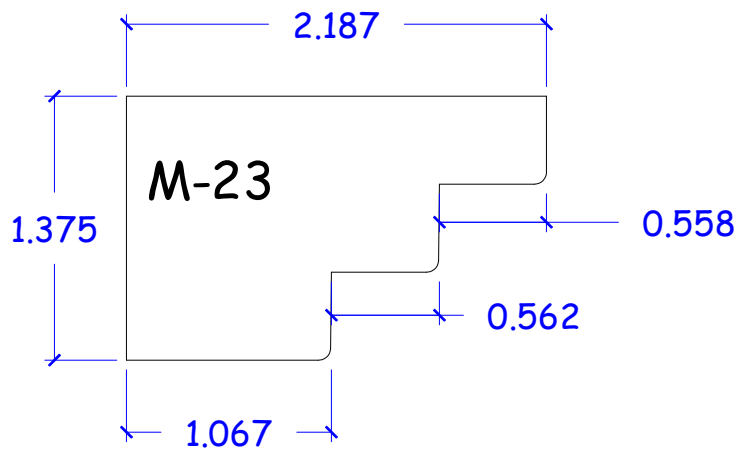
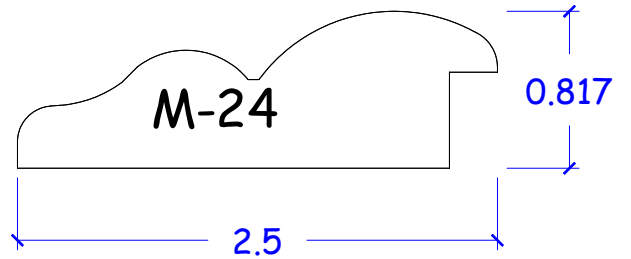
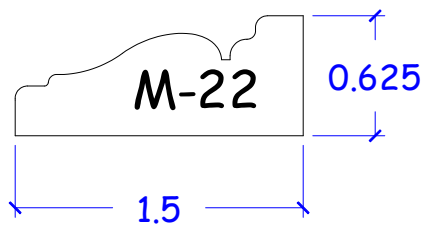
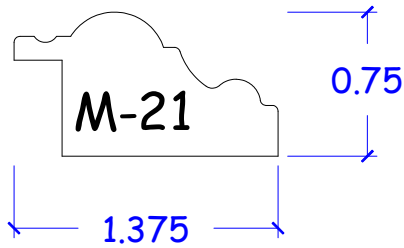
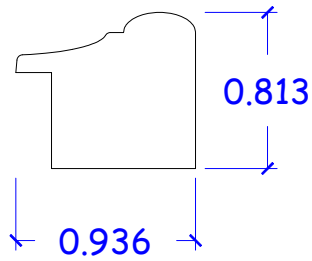

# MISC. Patterns

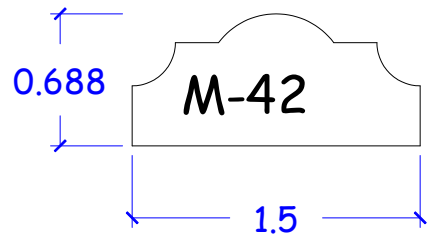
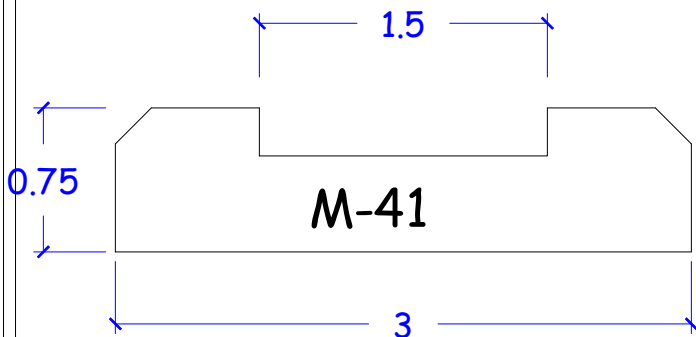
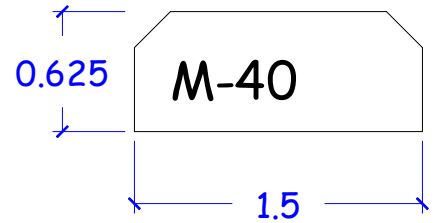
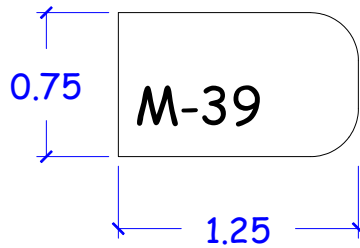
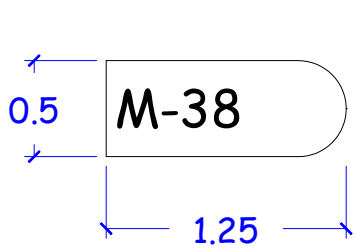
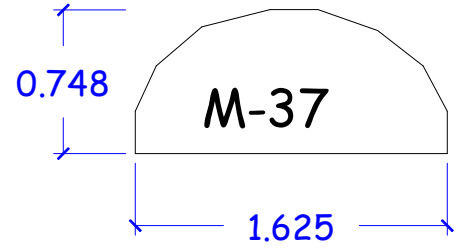
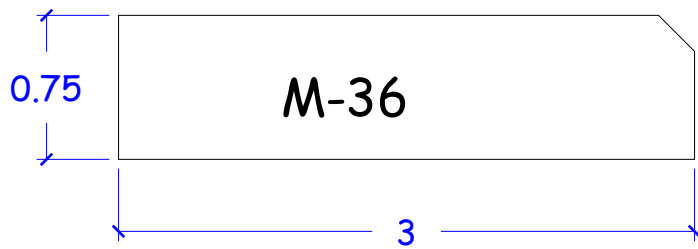
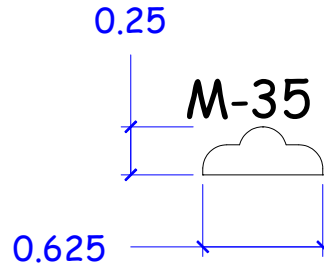
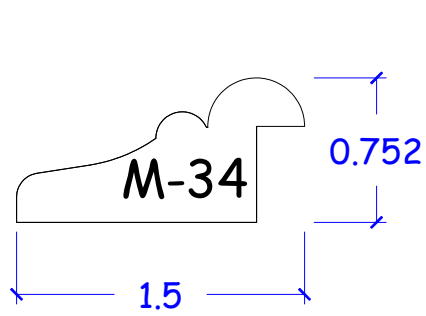
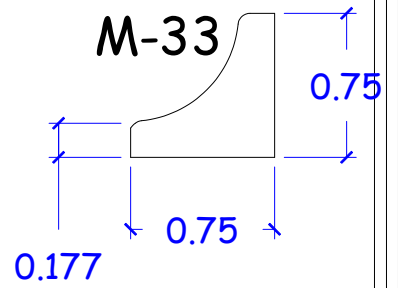
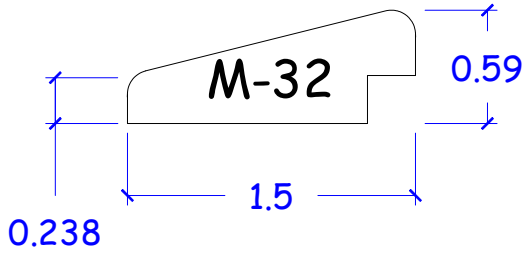
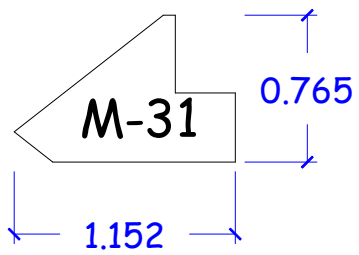

# MISC. Patterns

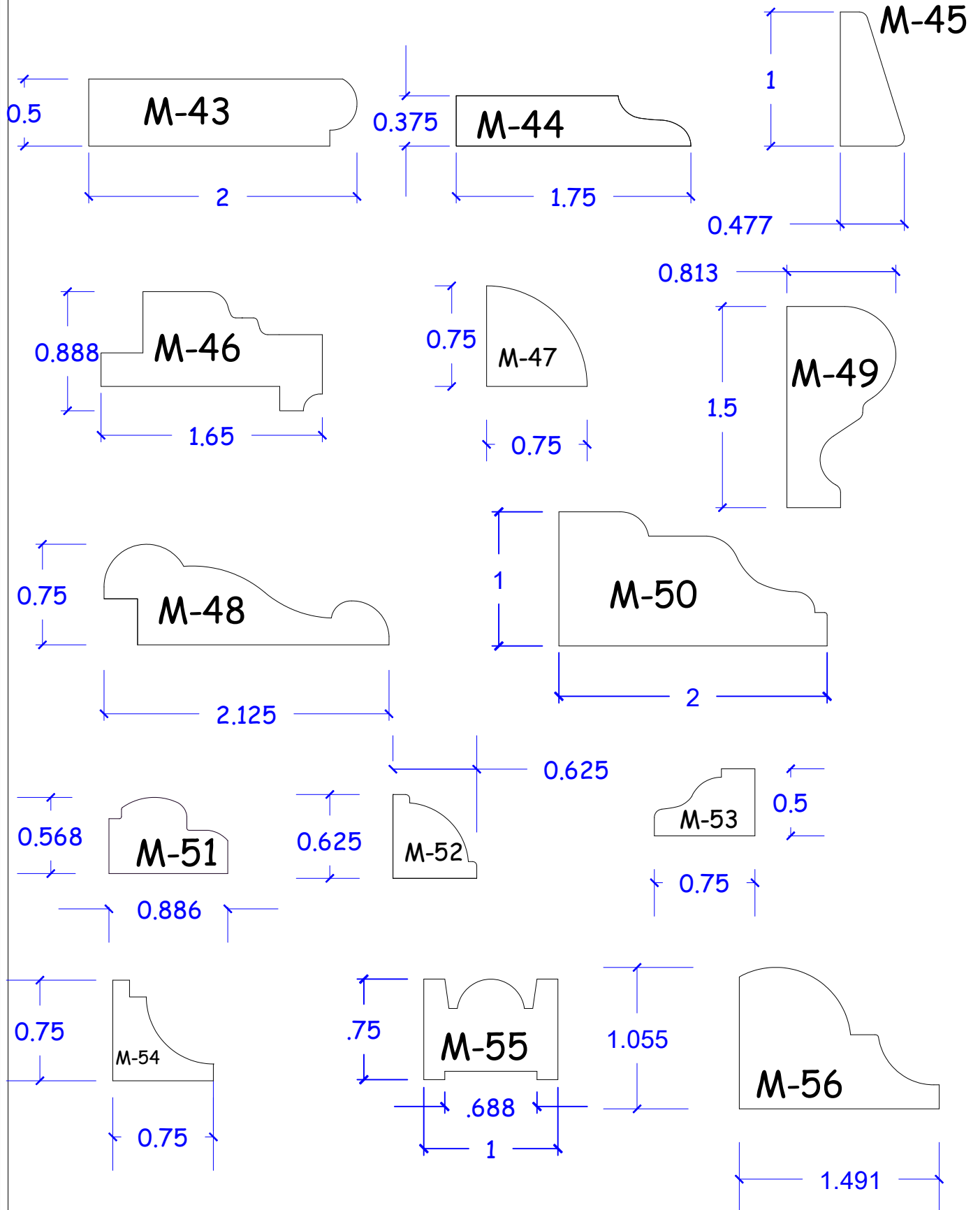

# MISC. Patterns

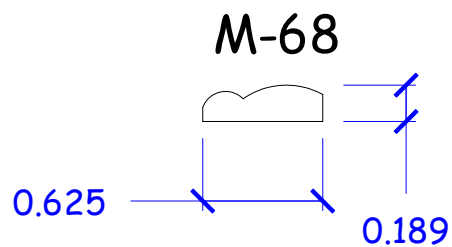
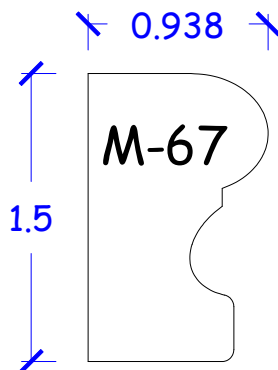
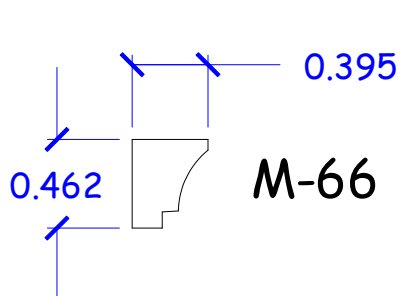
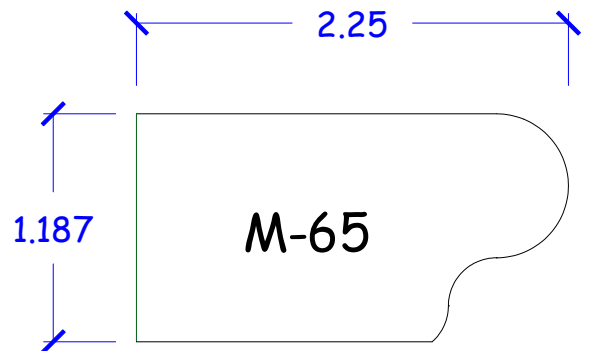
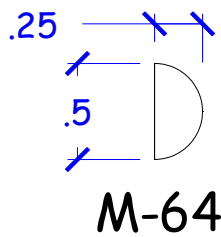
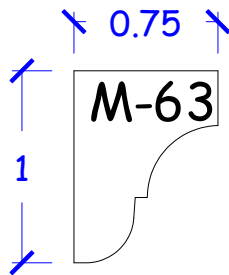
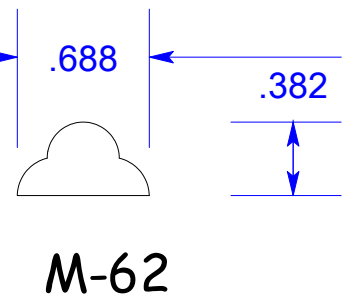
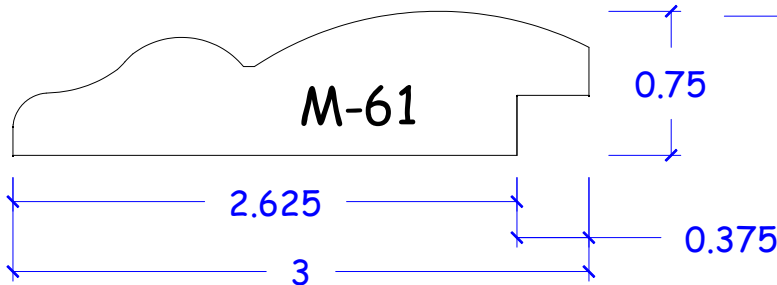
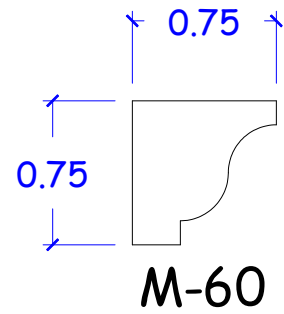
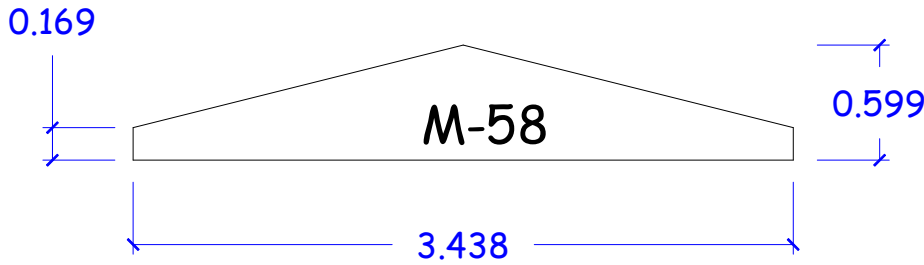
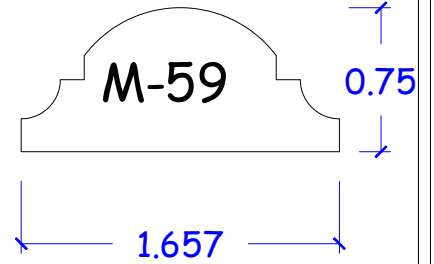
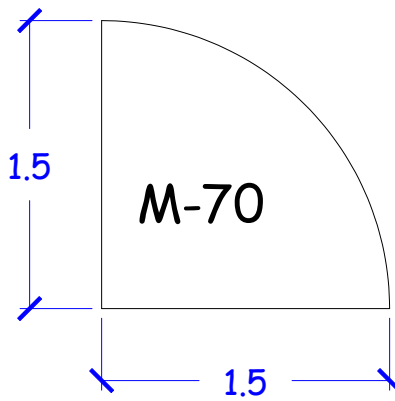
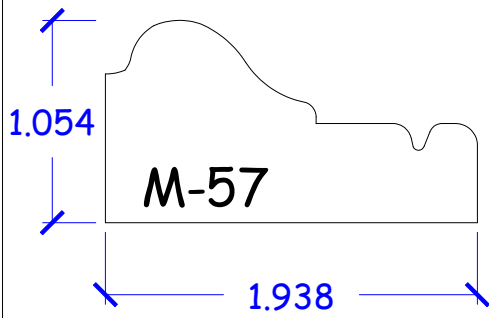

# MISC. Patterns

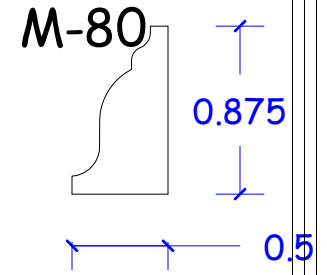
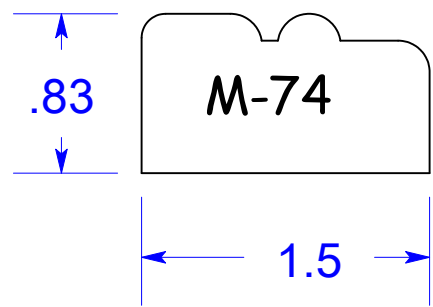
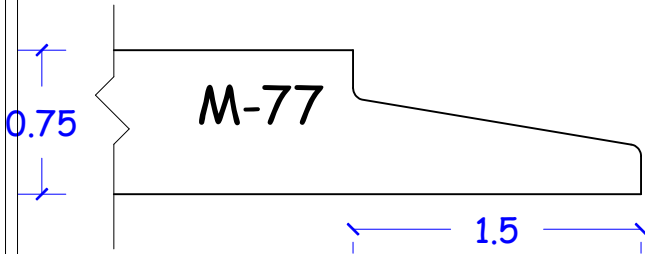
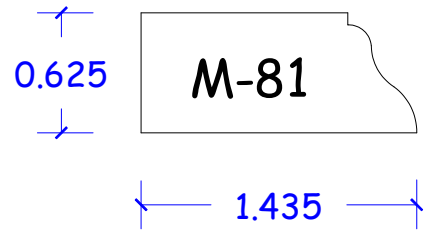
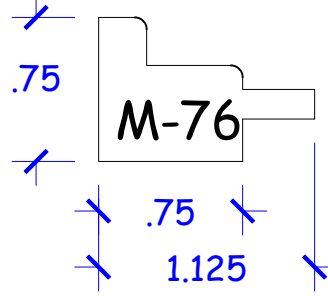
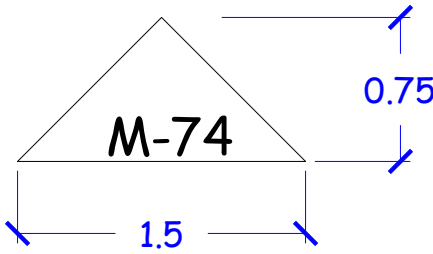
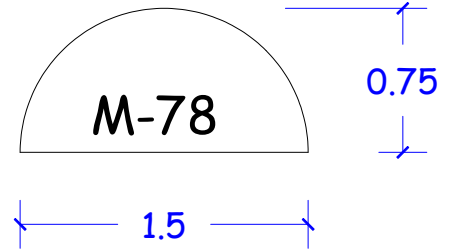
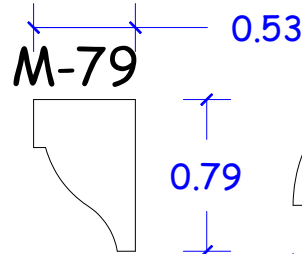
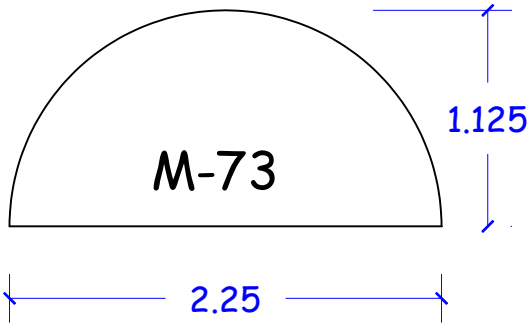
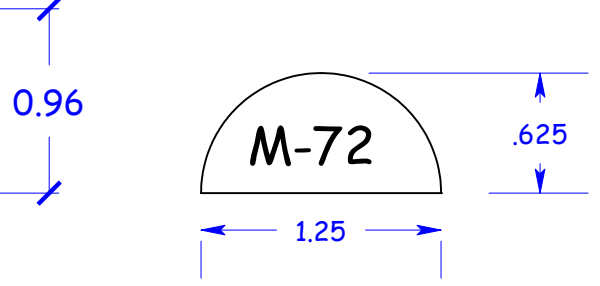
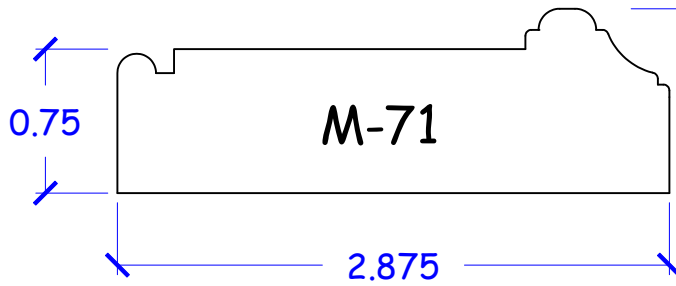
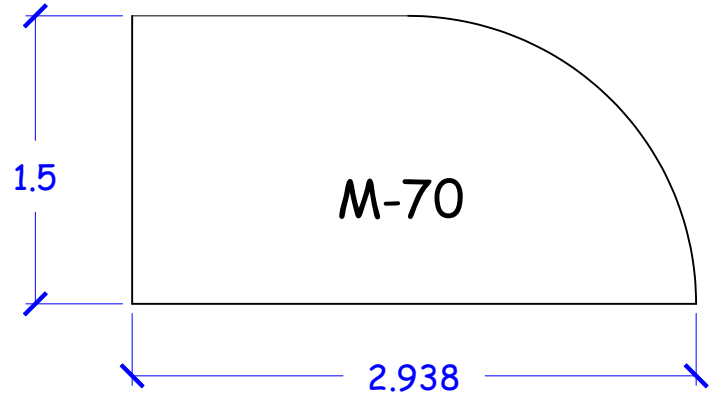
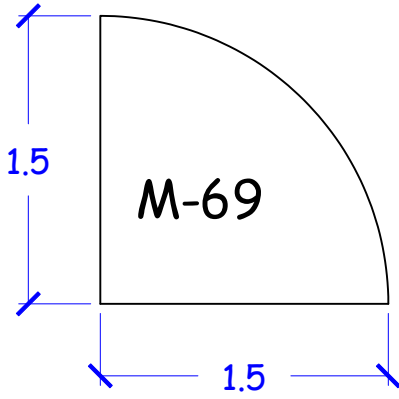



# MISC. Patterns

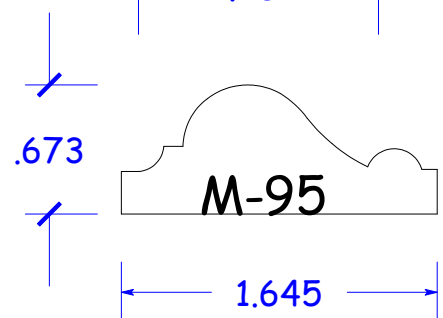
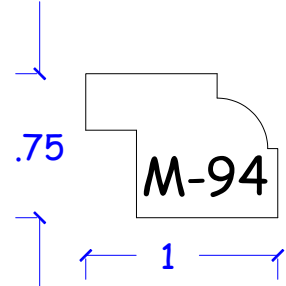
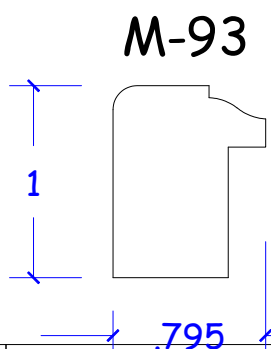
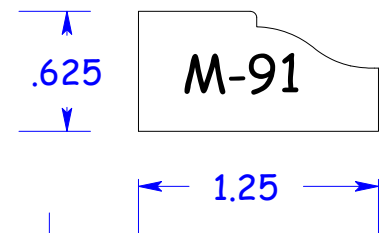
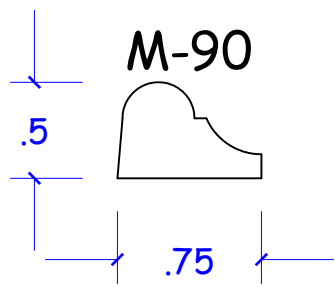
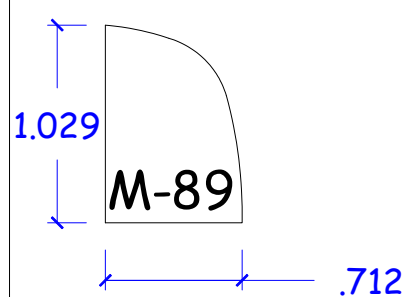
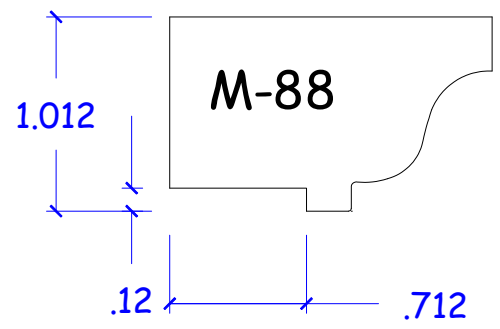
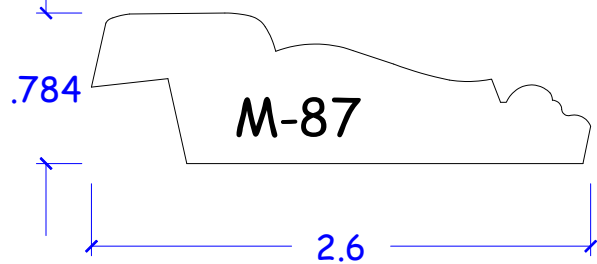
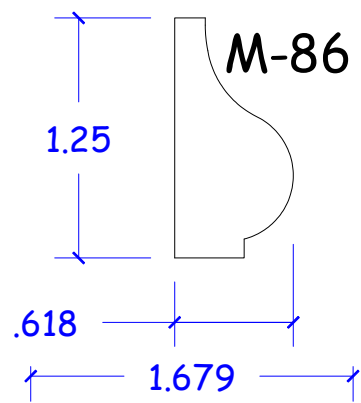
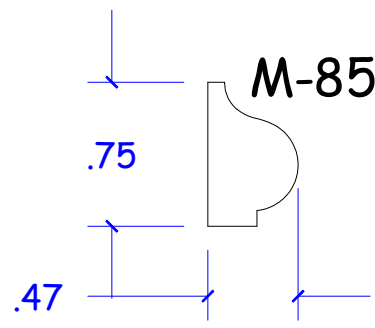
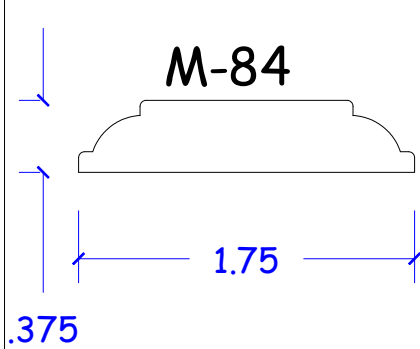
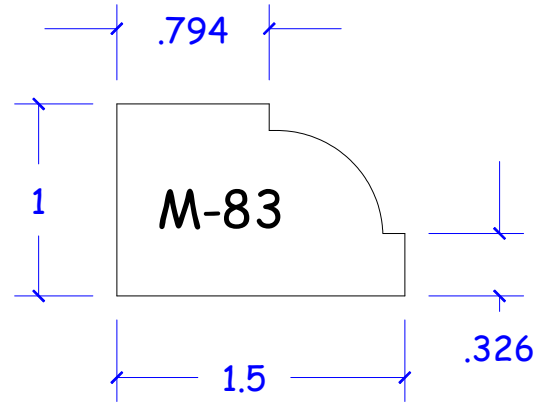
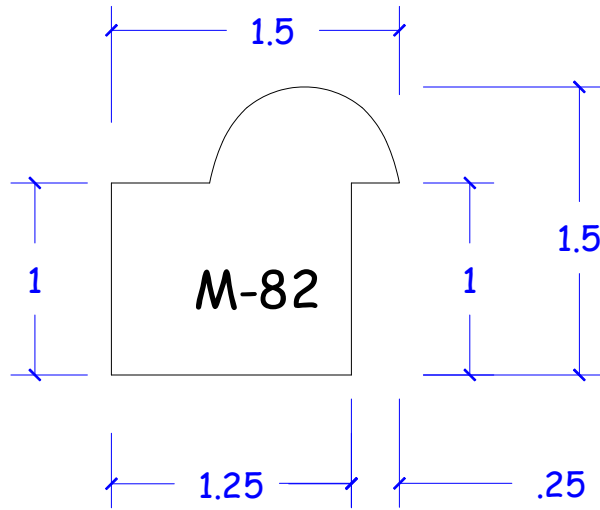

# MISC. Patterns

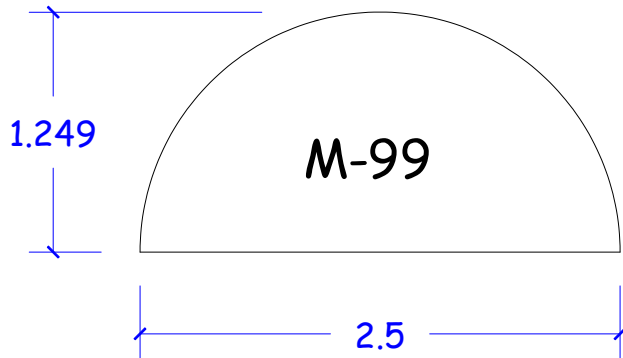
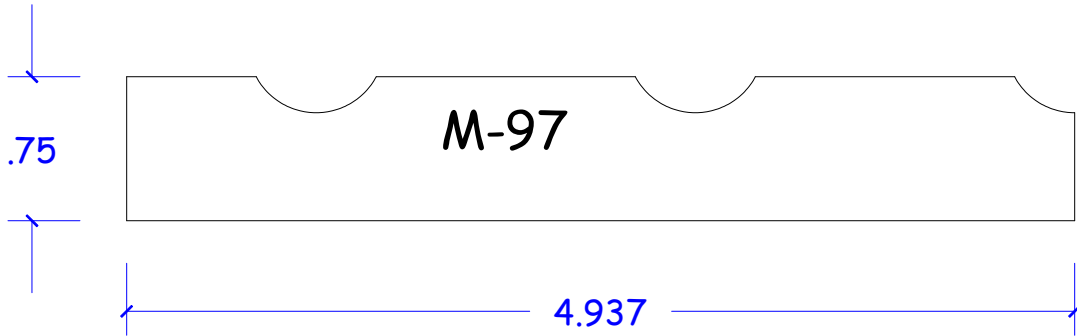
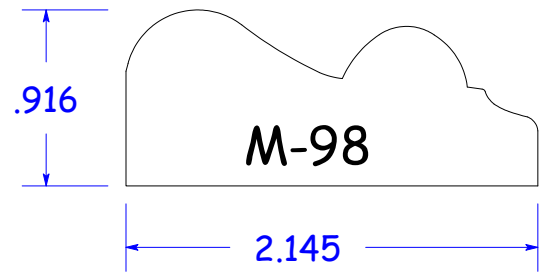
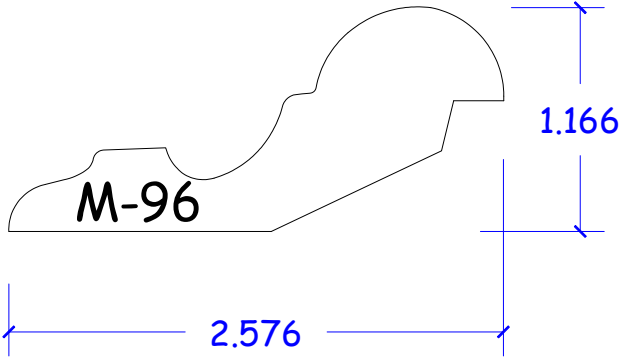

# T & G Patterns

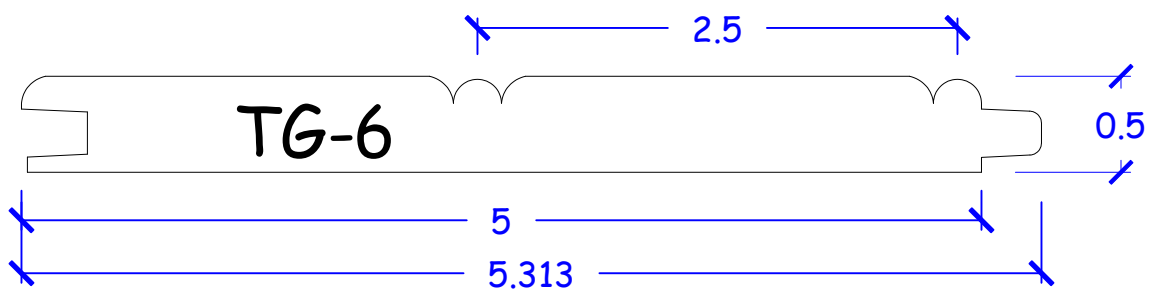
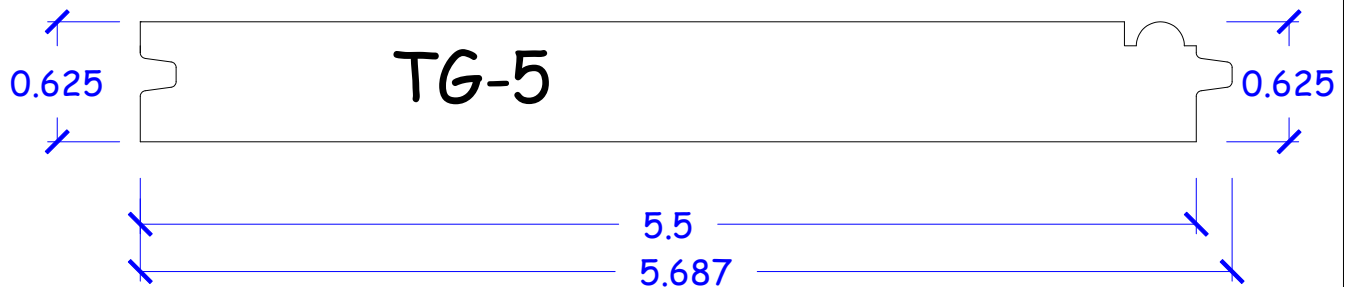
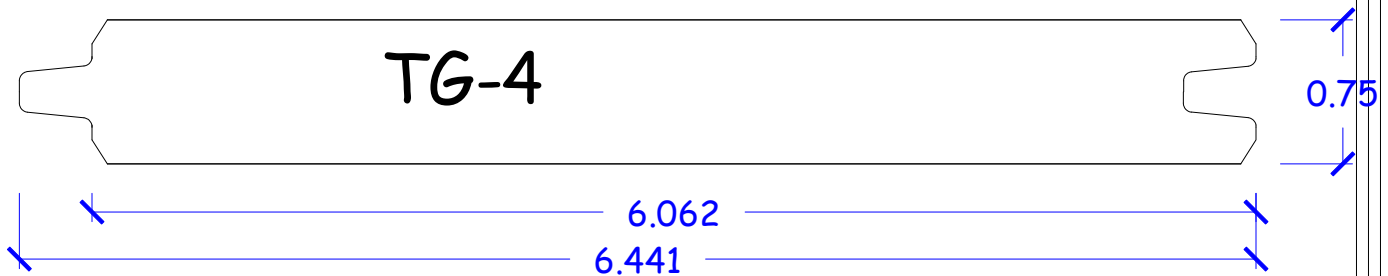
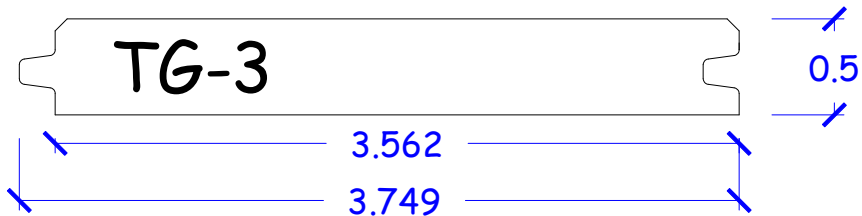
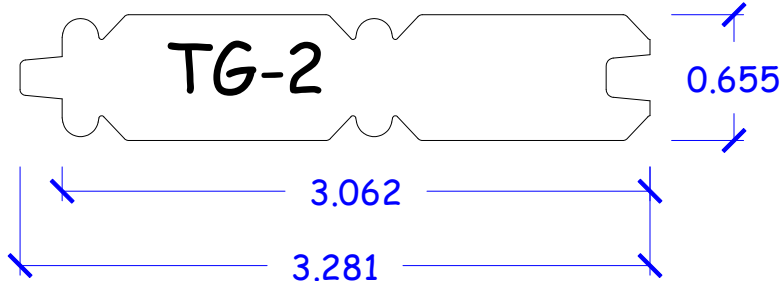
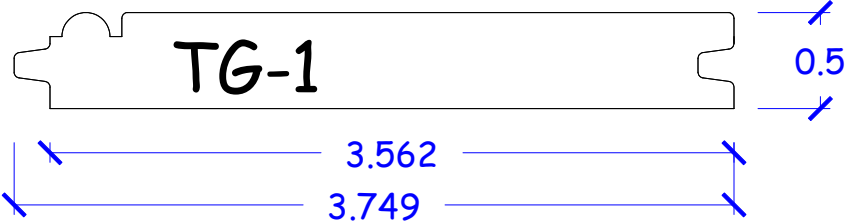

# T & G Patterns

Varies

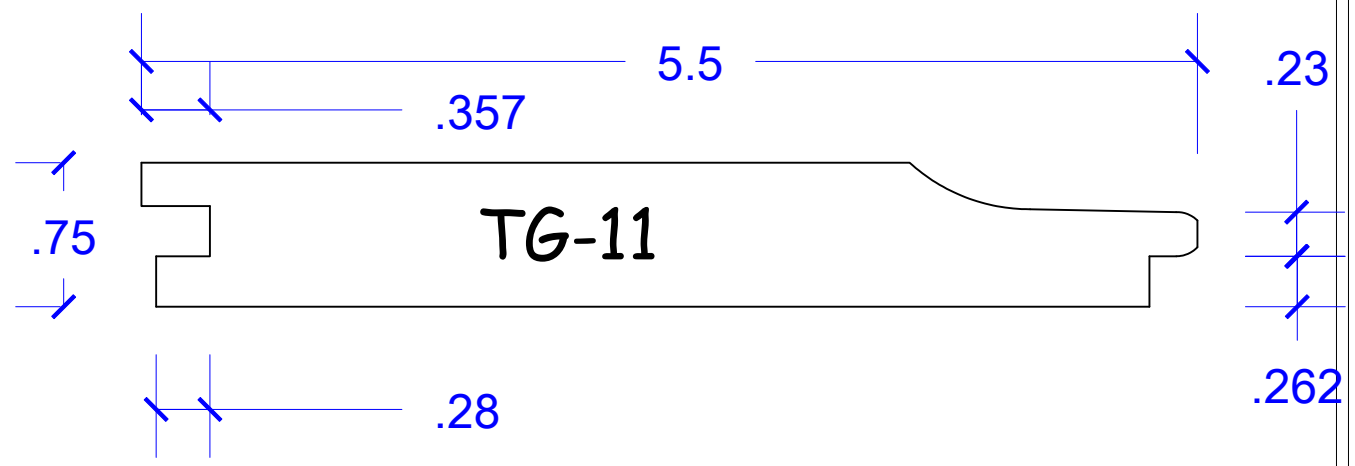
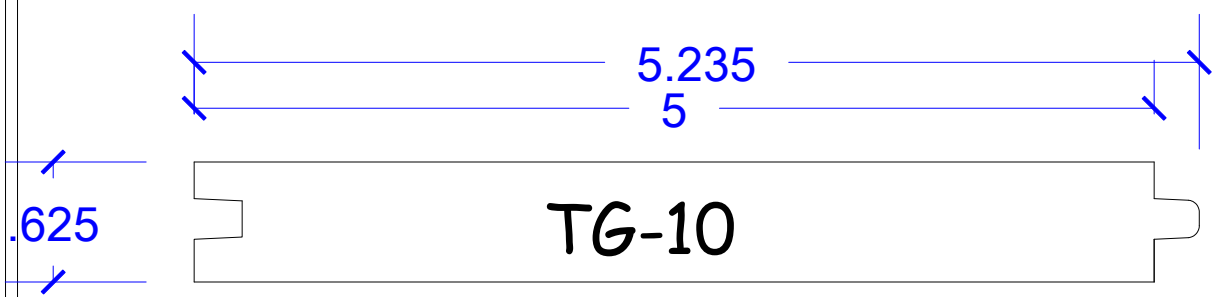
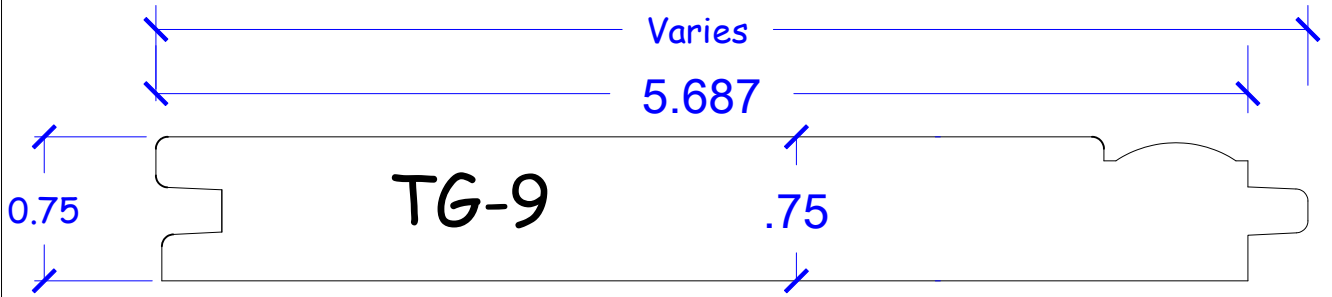
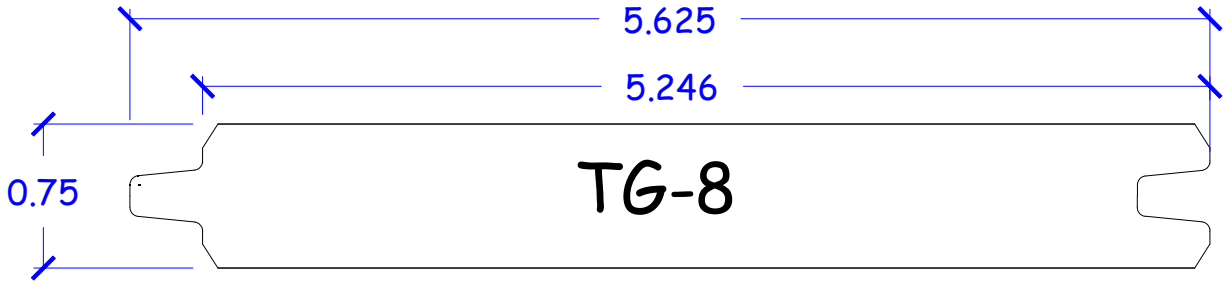
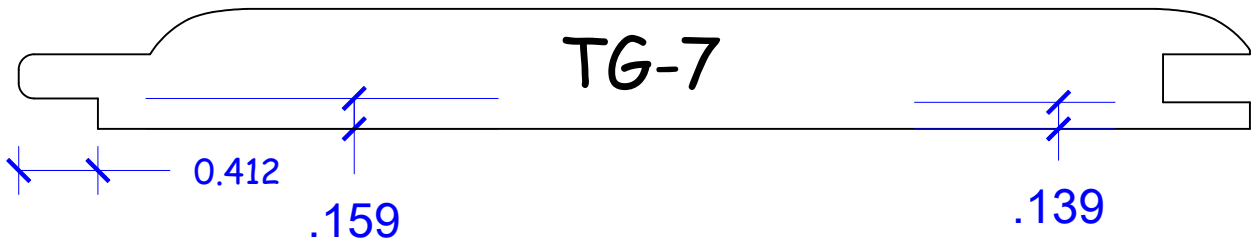

# T & G Patterns

